

Word Puzzles & Games



This Home Workbook belongs to:

**Use the incentive
chart on the inside
back cover to track
your child's progress**

You can also:





- Place a sticker on each completed page.
- Place a sticker on each page when your child meets a time-based or other predetermined goal.

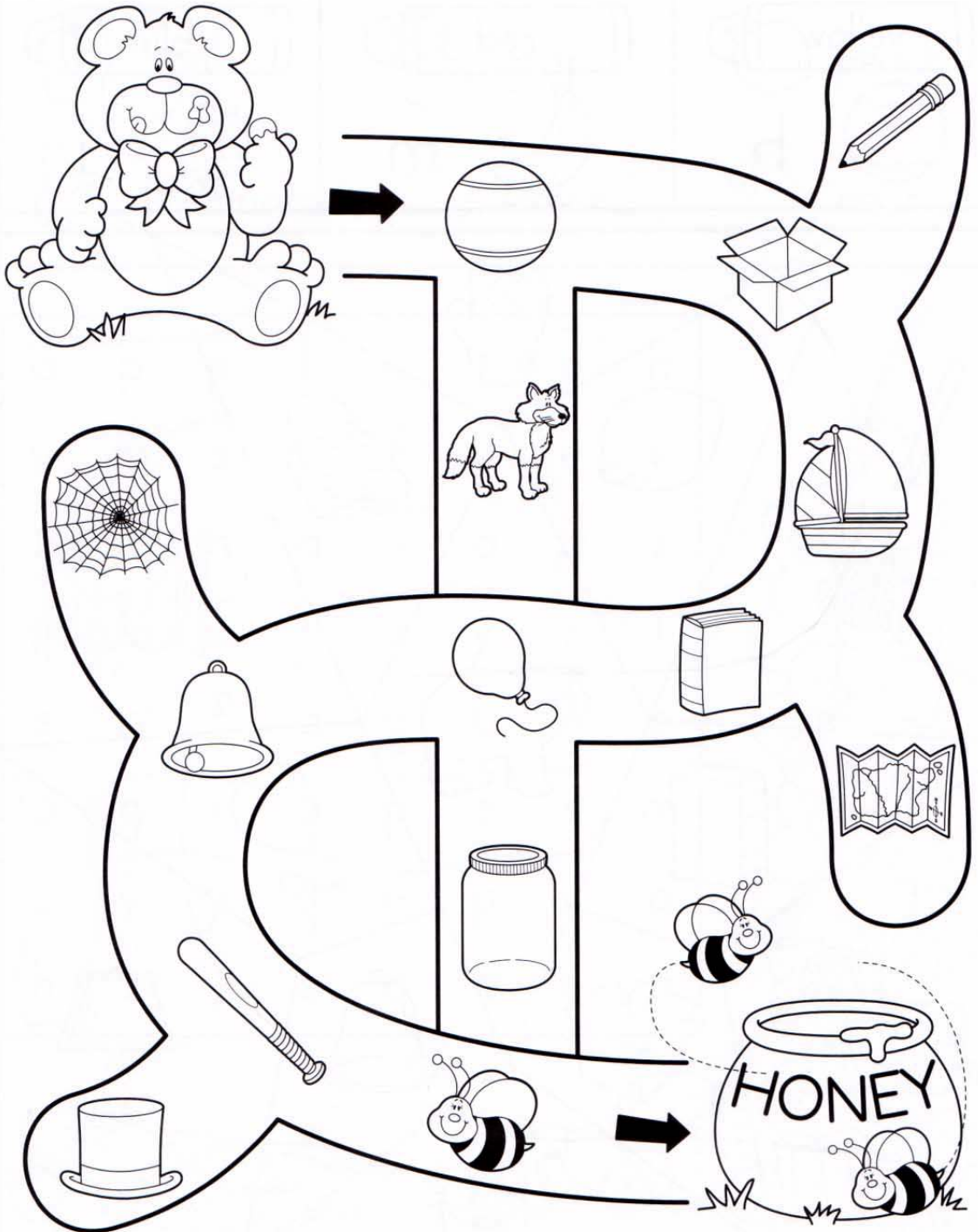

Draw a line along the path with pictures whose names **begin** with the **b** sound to help the bear find the honey.

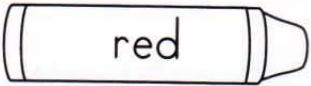

Use the key to color the spaces with pictures whose names **begin** with the same letter sounds.

 yellow	 red	 blue
 b	 m	 l

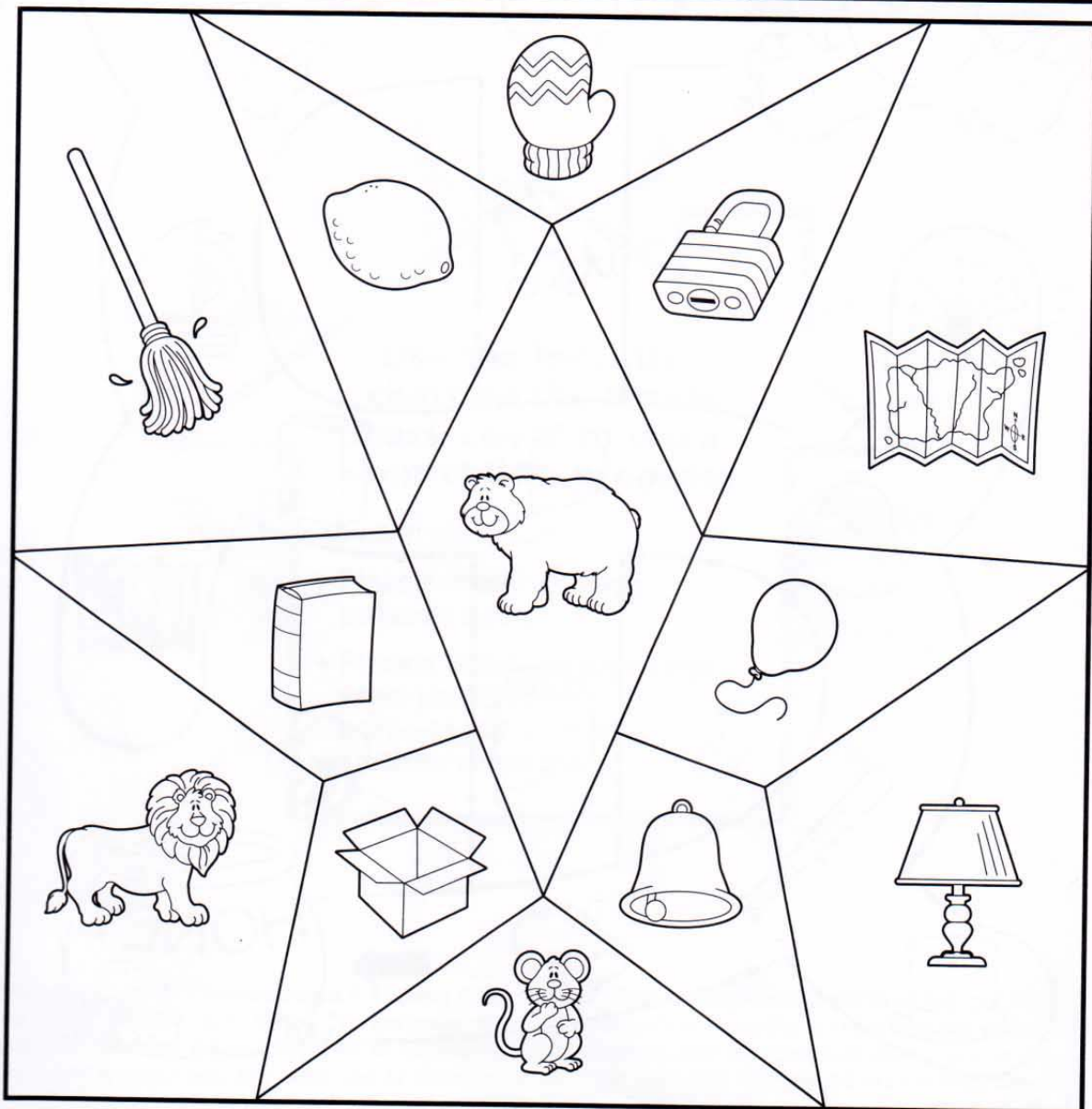

The large square is divided into 12 triangles. The objects in the triangles are:

- Top: A mitten with a zigzag pattern.
- Top-right: A padlock.
- Right: A folded map.
- Bottom-right: A balloon.
- Bottom: A bell.
- Bottom-right: A lamp.
- Bottom: A mouse.
- Bottom-left: An open box.
- Left: A lion.
- Bottom-left: A book.
- Center: A bear.
- Top-left: A broom.
- Top-left: A lemon.

Circle the words from the word box in the puzzle below.



apple



grapes



peach



banana



lemon



pear

a	p	p	l	e	j	p	h
y	m	s	v	f	v	e	v
b	a	n	a	n	a	a	z
p	u	s	j	z	y	r	l
e	n	f	a	g	b	n	e
a	g	r	a	p	e	s	m
c	y	y	g	e	p	v	o
h	z	y	s	q	d	e	n

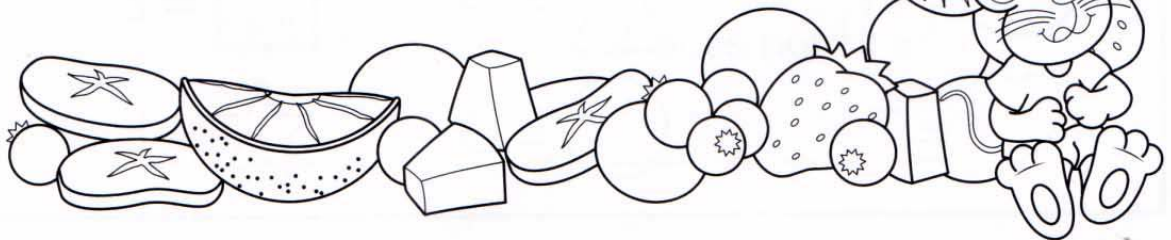
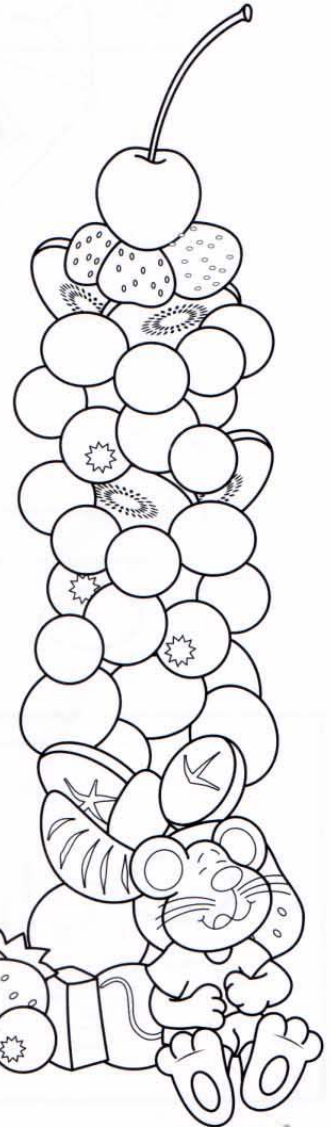

Use the secret code to solve the riddle.

Where do owls stay when they go on a trip?

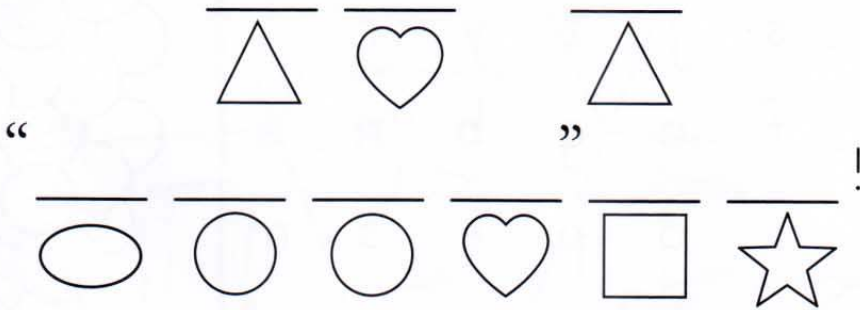
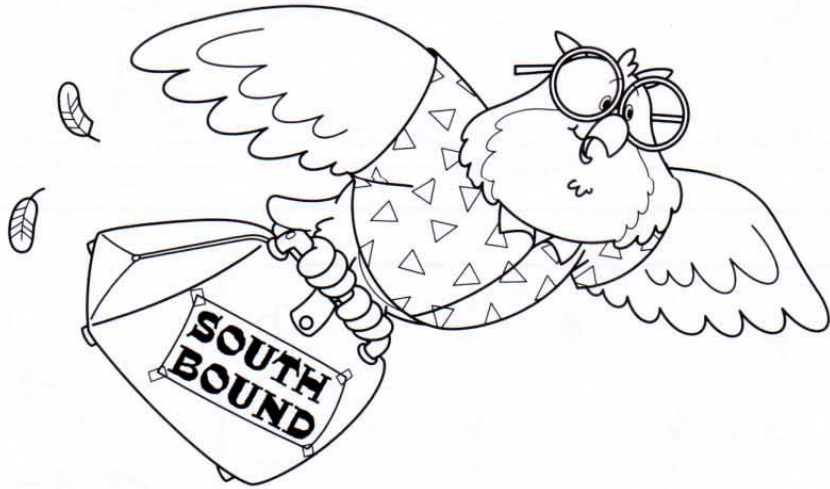

Secret Code

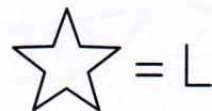
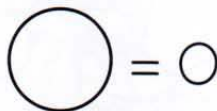
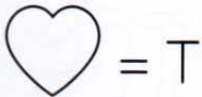
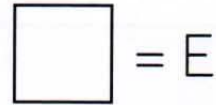
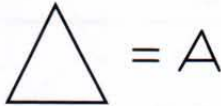
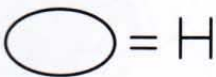

Unscramble each word and write it on the lines. Then, write the circled letters in order to answer the riddle.



t c a

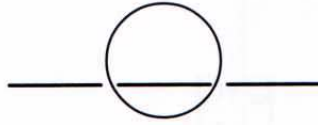

o a c t

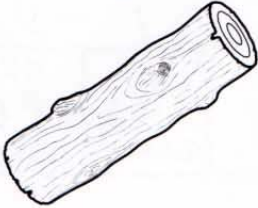
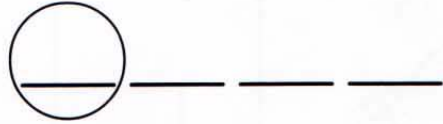

g o l

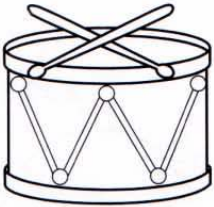
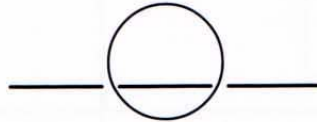

r d u m

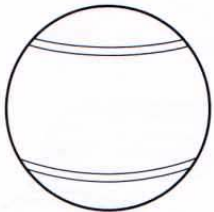
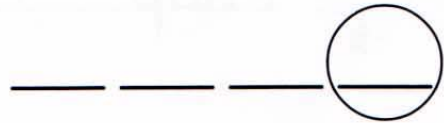

a l l b



What has teeth but does not bite?

Draw lines to match the words with the same **short vowel** sound. Circle the picture that is left. It is the answer to the riddle: What has four legs but only one foot?

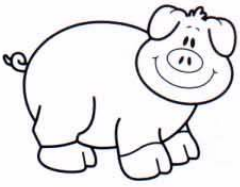

pig

cap

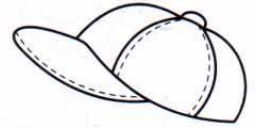

crab

frog



mop

hill

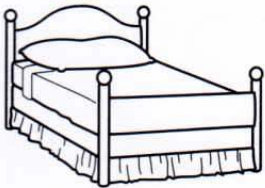

bed

bug

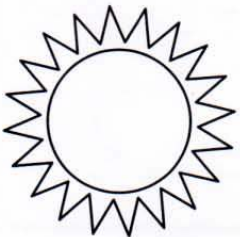
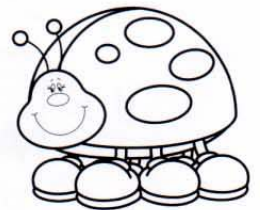

sun

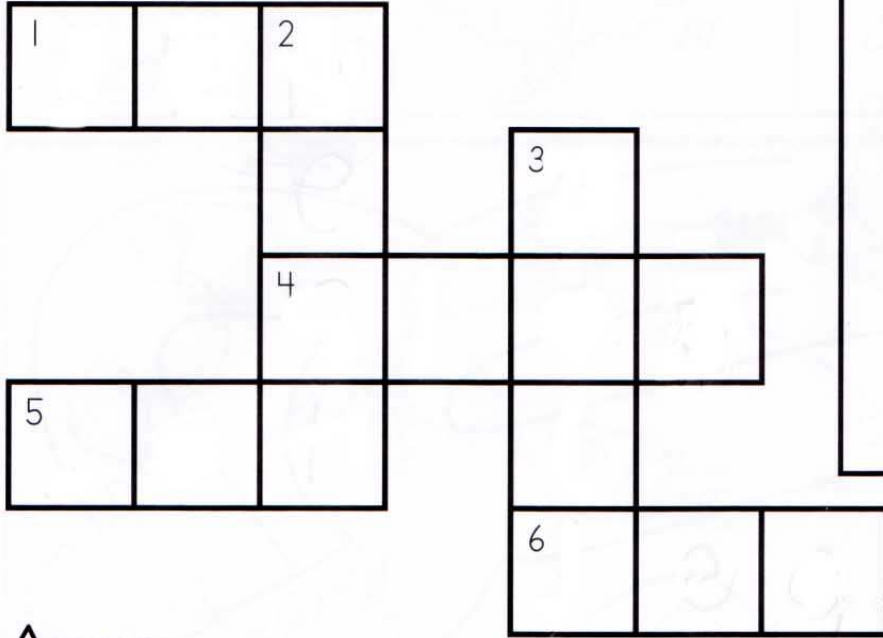

Use the words from the word list to solve the crossword puzzle.



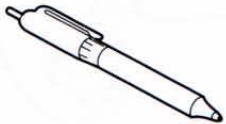
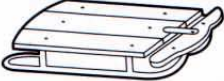

Word List

bell
jet
leg
nest
pen
sled

Across

- 1. 
- 4. 
- 5. 
- 6. 

Down



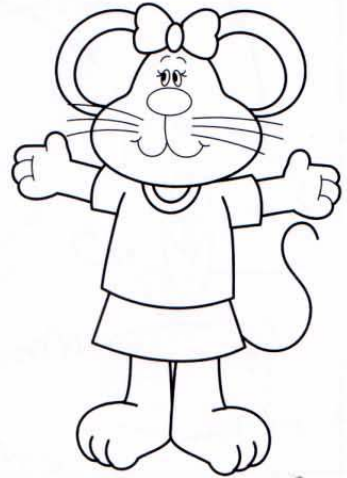

- 2. 
- 3. 

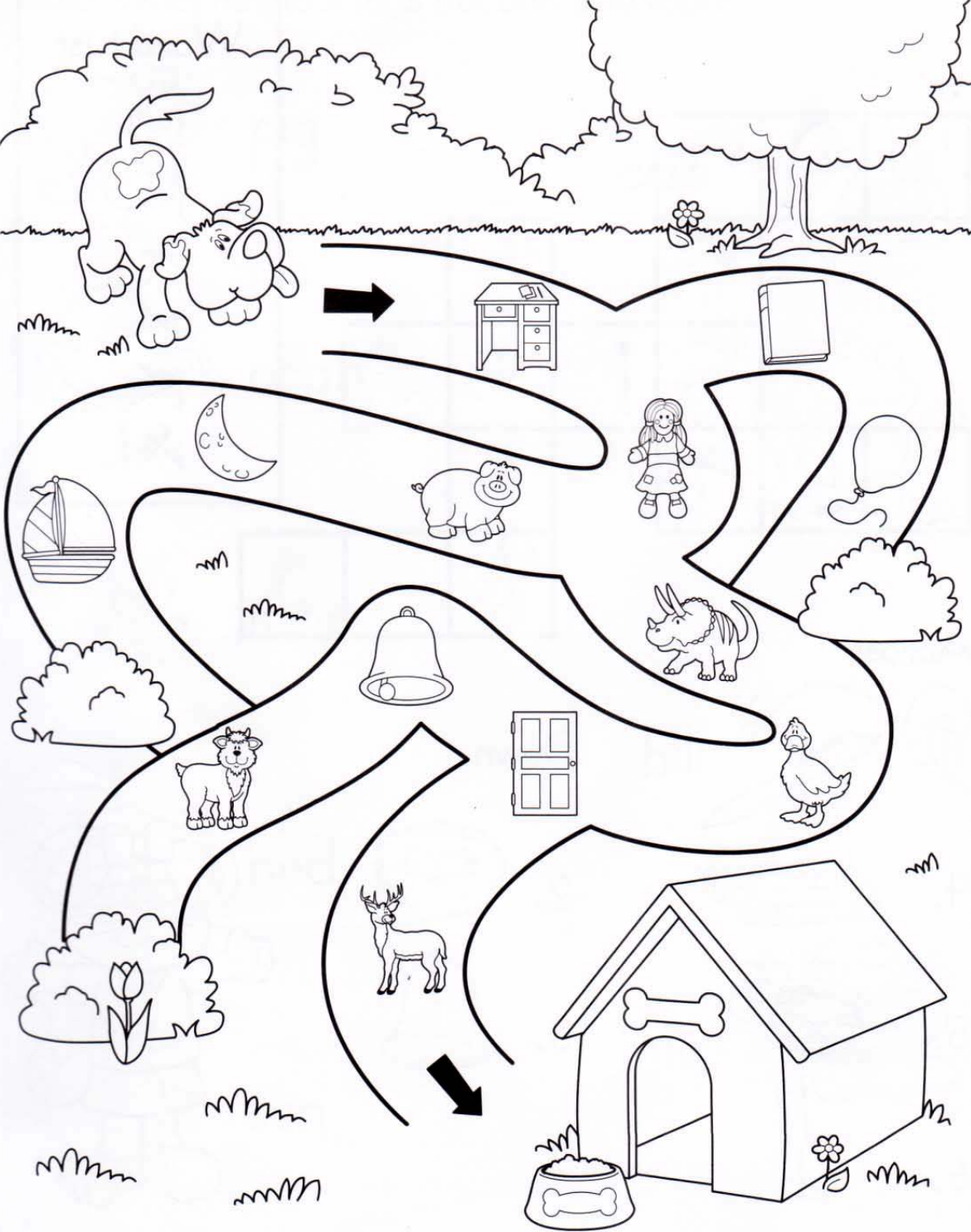

Draw a line along the path with pictures whose names **begin** with the **d** sound to help the dog find the doghouse.

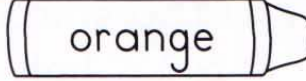
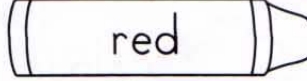





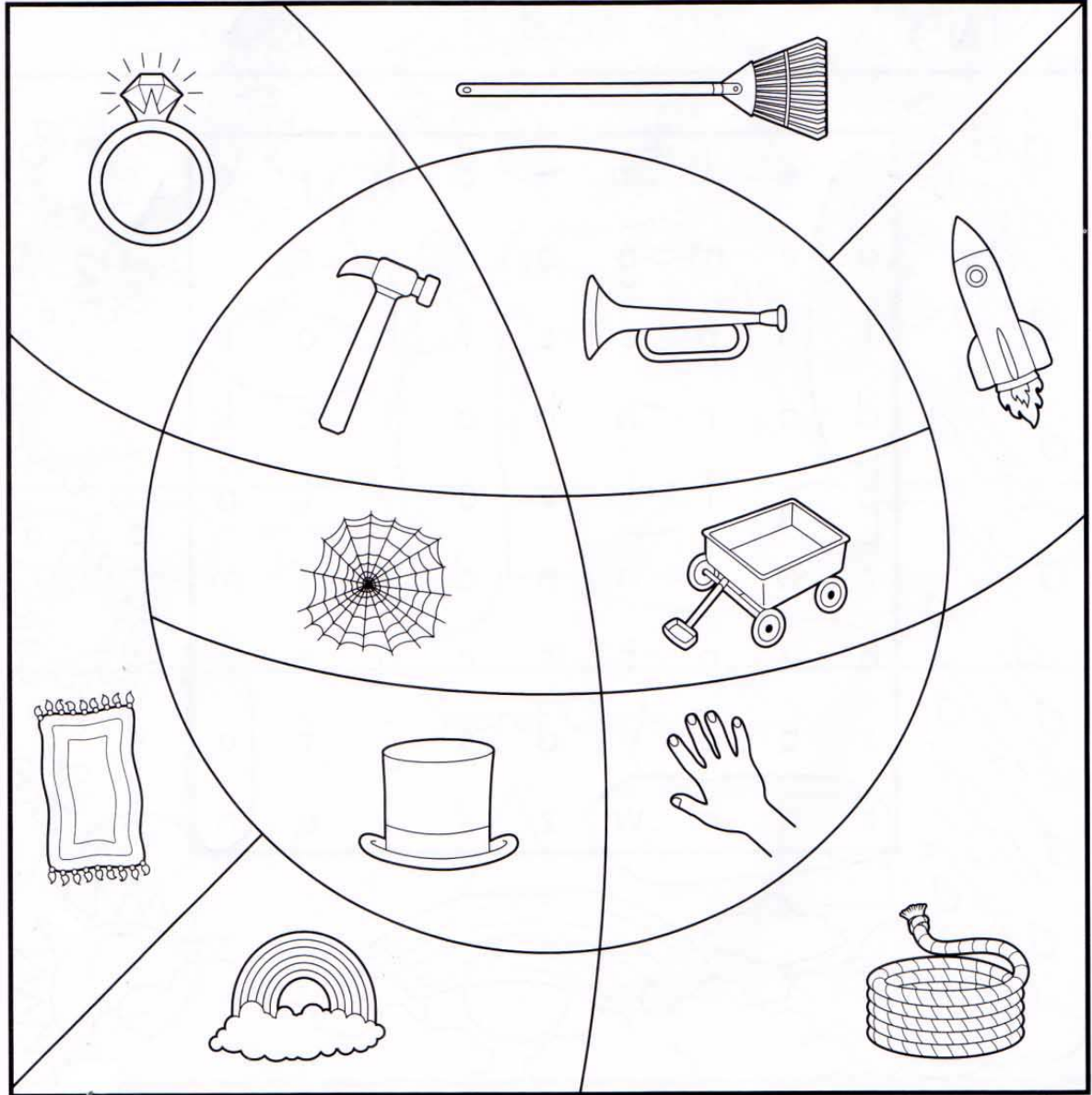

Use the key to color the spaces with pictures whose names **begin** with the same letter sounds.

 yellow	 orange	 red
 r	 w	 h



Circle the words from the word box in the puzzle below.

	cloud		hot		snow
	cold		rain		sun

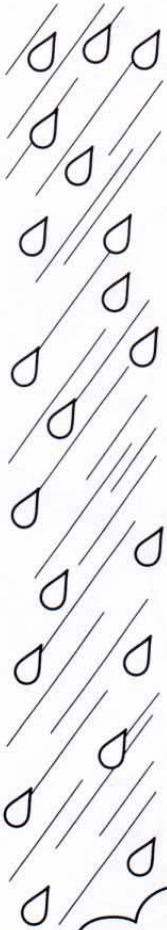

c	e	l	m	v	o	b	j	s
o	v	m	g	o	c	y	r	c
l	h	p	e	z	l	h	o	t
d	o	r	n	b	o	i	o	k
b	q	f	k	v	u	y	f	g
r	a	i	n	n	d	y	z	m
h	v	n	t	s	r	q	r	s
x	b	p	y	o	s	j	f	u
s	n	o	w	z	x	l	e	n

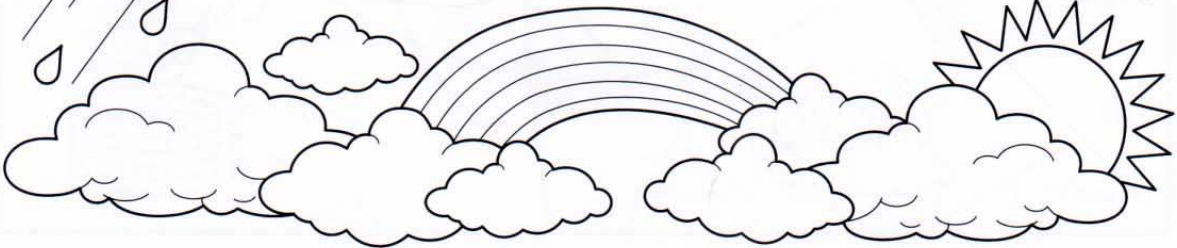

Use the secret code to solve the riddle.

What game do bunnies like?

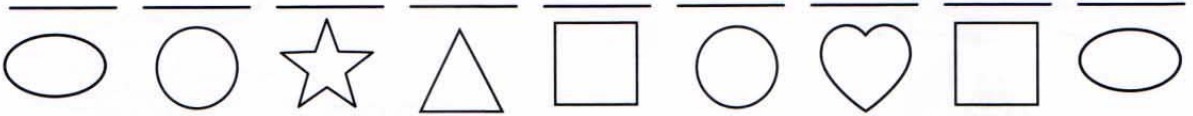
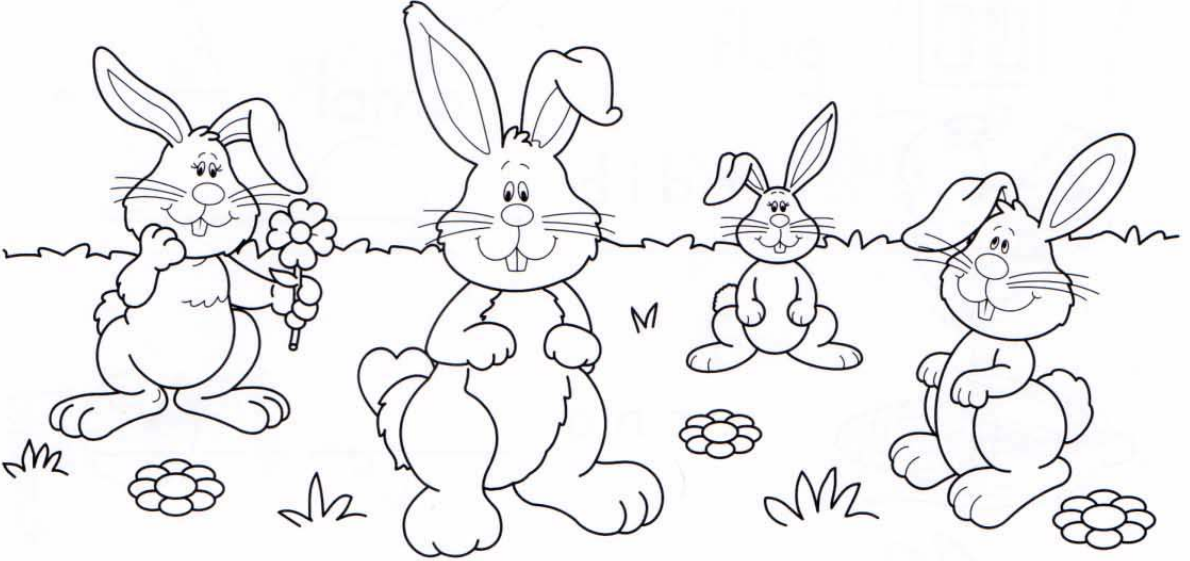

Secret Code

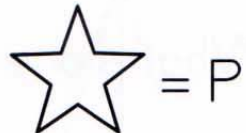
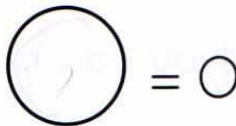
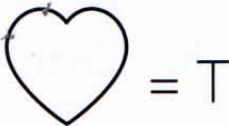
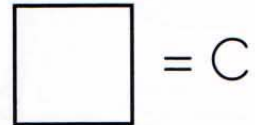
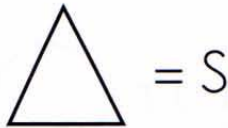
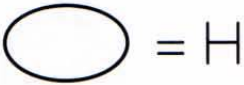

Unscramble each word and write it on the lines. Then, write the circled letters in order to answer the riddle.

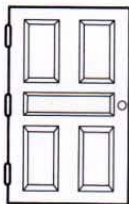

r o o d  _____



r d i b _____  _____

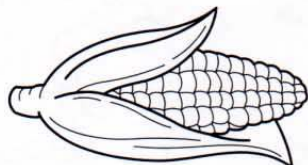

c r n o _____ 

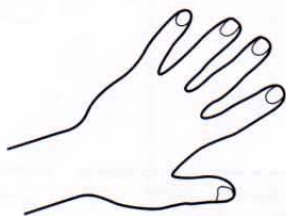

d a h n _____ 



l u g e _____ 

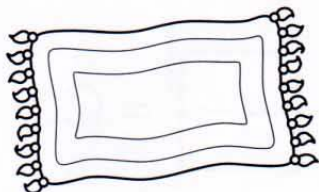

g u r  _____

What is one thing you can never have for lunch?

Draw lines to match the words with the same **ending** sound. Circle the picture that is left. It is the answer to the riddle: What goes up when rain comes down?



lamp

flag

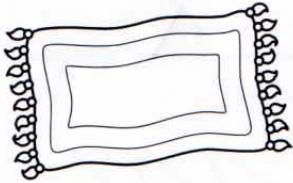
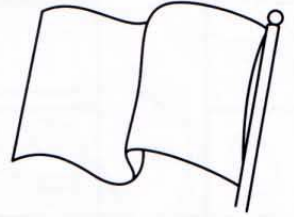

rug

bell

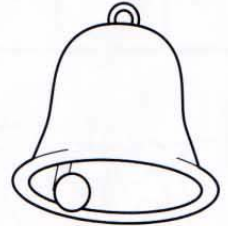

coat

jeep

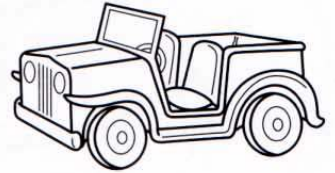

umbrella



girl



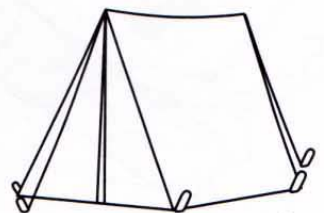

tent

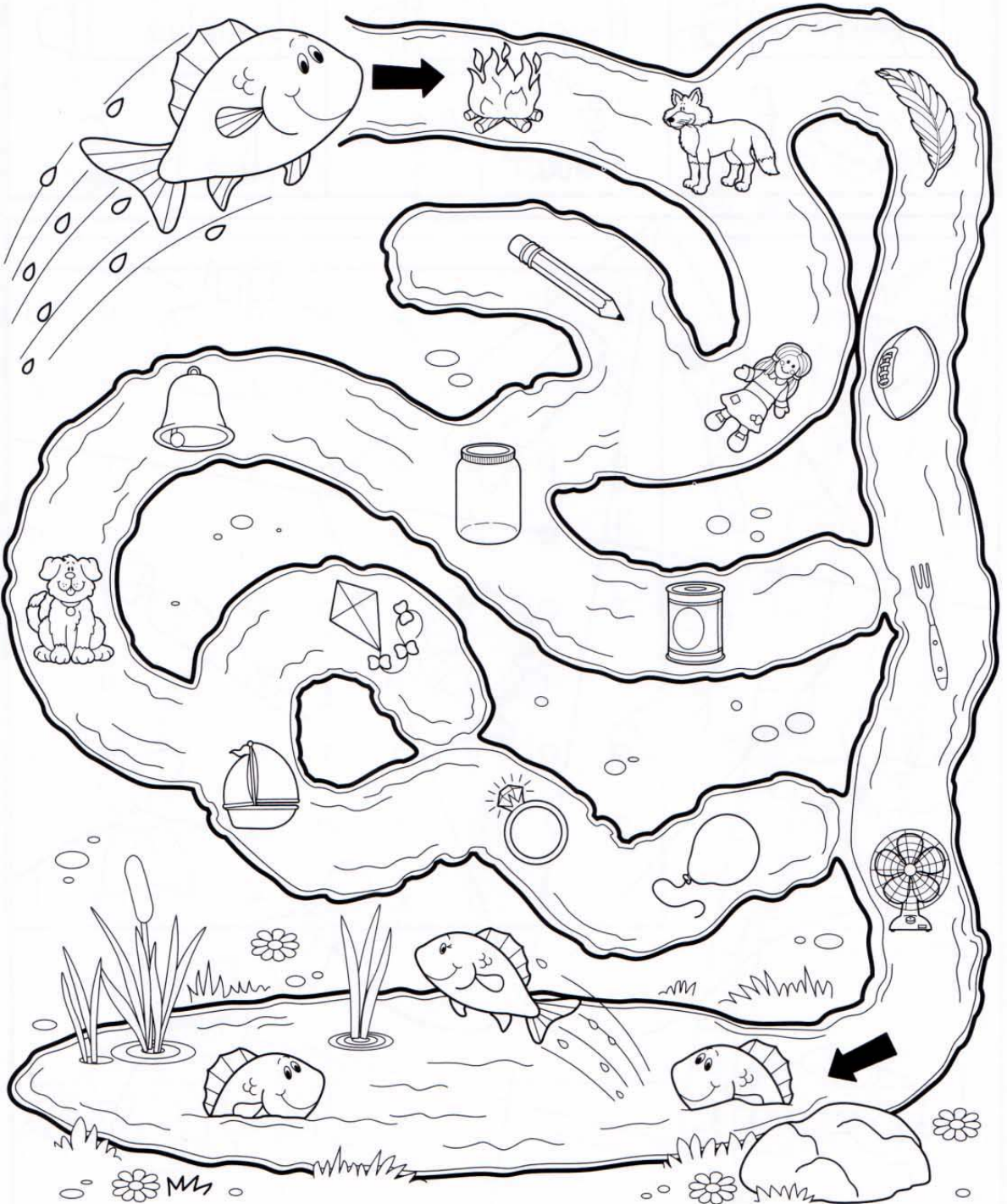

Draw a line along the path with pictures whose names **begin** with the **f** sound to help the fish find the pond.

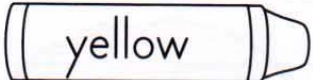

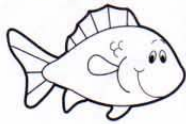
Use the key to color the spaces with pictures whose names **begin** with the same letter sounds.

 yellow	 purple	 blue
 f	 s	 c

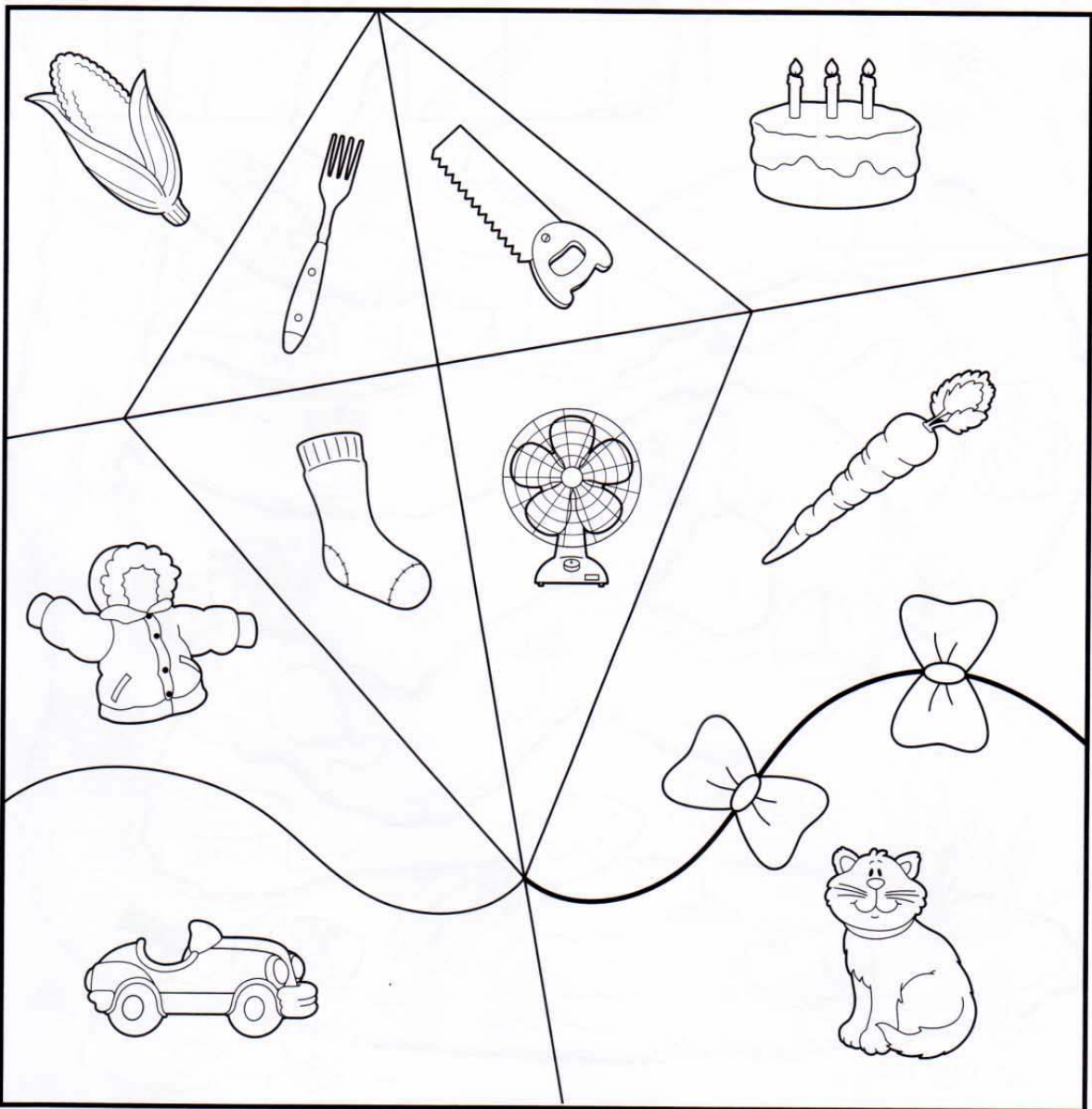

Circle the words from the word box in the puzzle below.

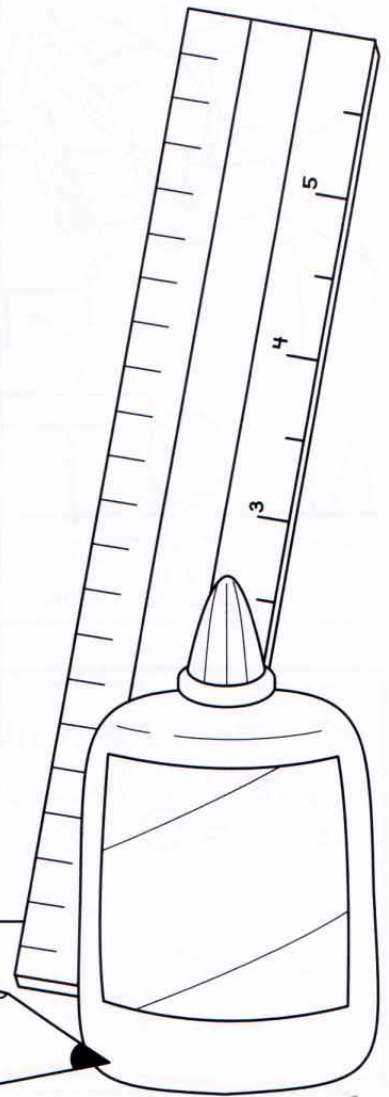
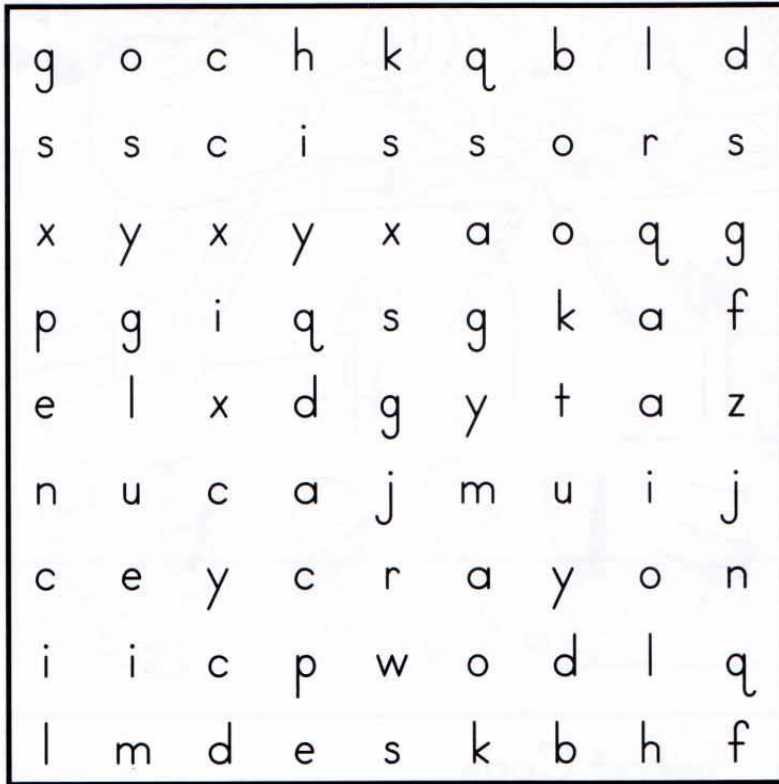

Use the secret code to solve the riddle.

What kind of books do musicians read?

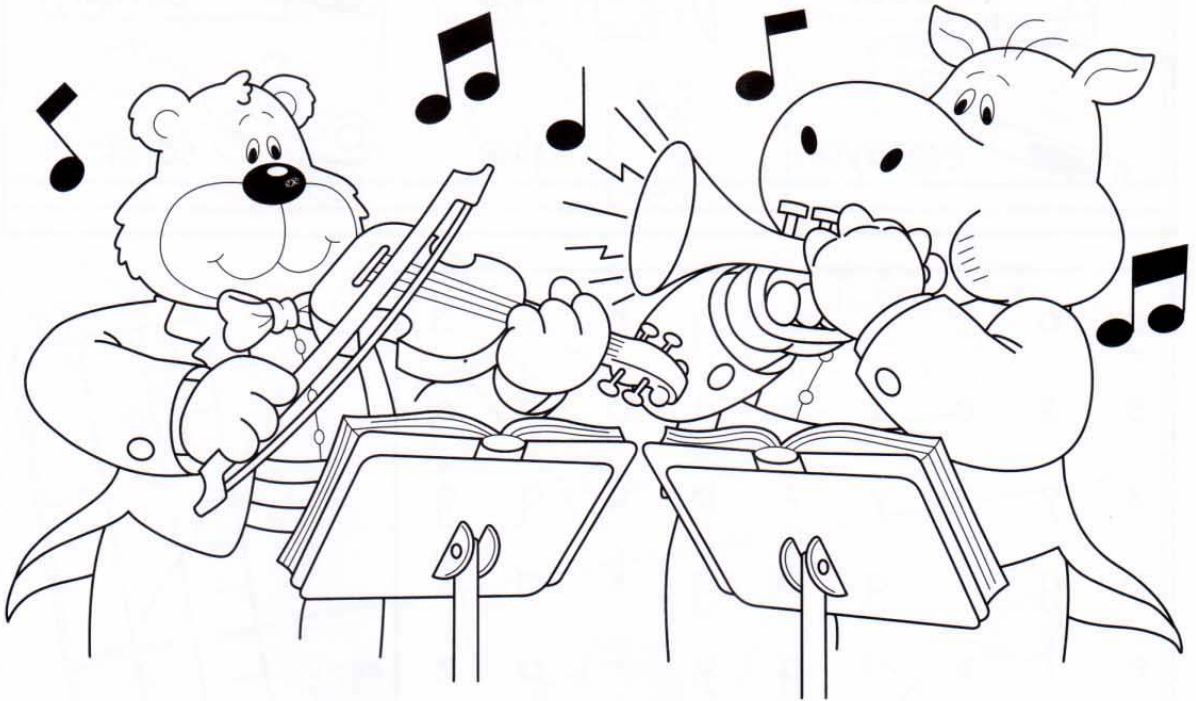

Secret Code

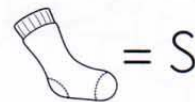
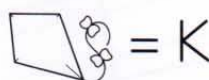
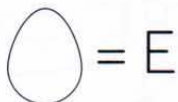
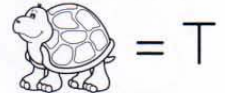
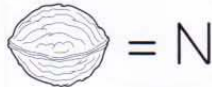
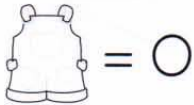

Unscramble each animal name and write it on the lines.
Write the circled letters in order to find the secret word.

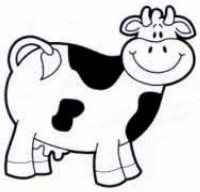

w c o  _____

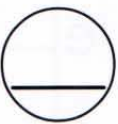

p e e s h _____  _____

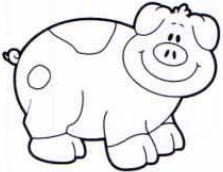

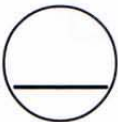
g i p _____  _____

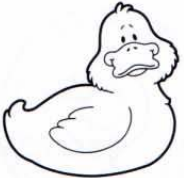

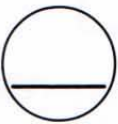

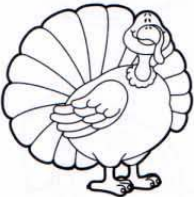
k d u c _____  _____



y t u r k e _____  _____

Secret Word

 Draw a picture of the secret word. 

Draw lines to match the words with the same **beginning** sound. Circle the picture that is left. It is the answer to the riddle: What has a head and a tail, but no body?

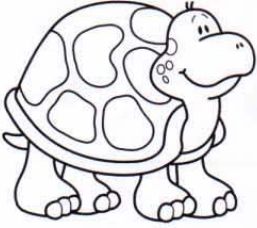

turtle

table

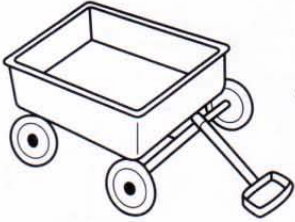
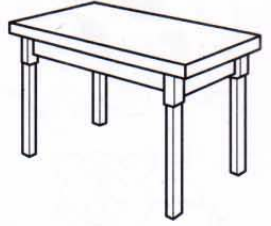

wagon

book

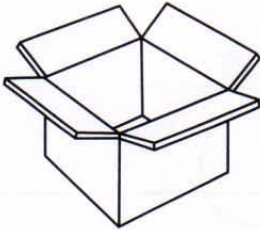

box

coin

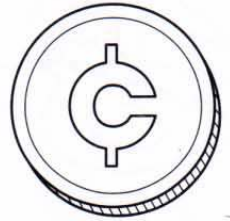

watch

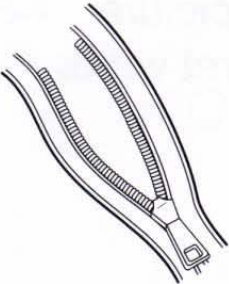

zipper

zebra



Use the words from the word list to solve the crossword puzzle.

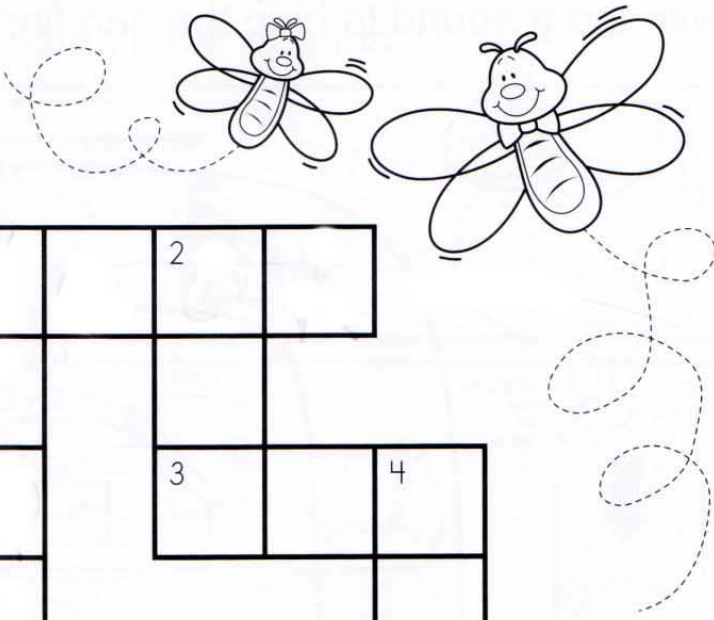

Word List

bug
cub
drum
duck
gum
gum
mug

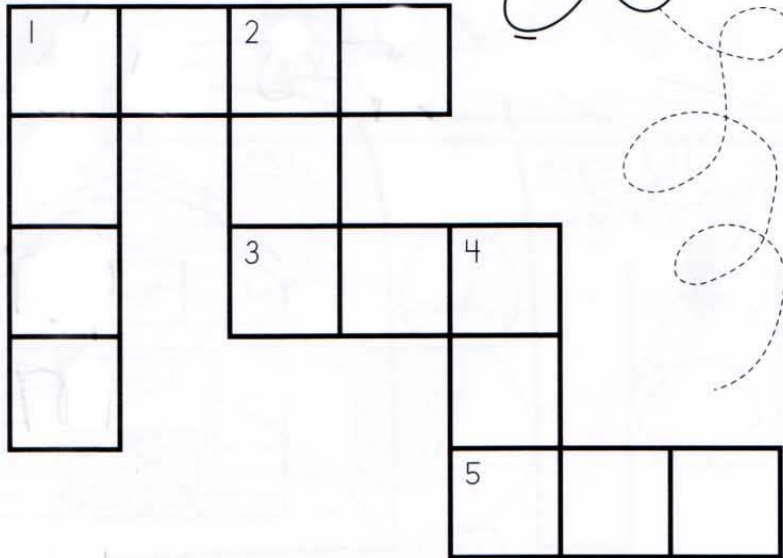

Across

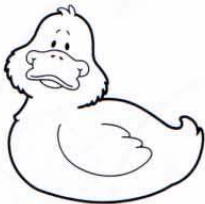
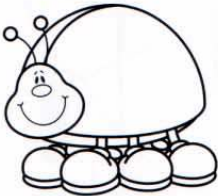
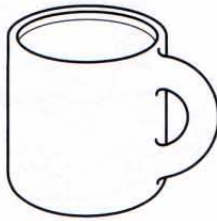
1. 
3. 
5. 



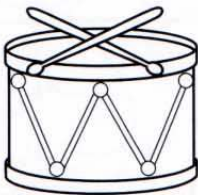
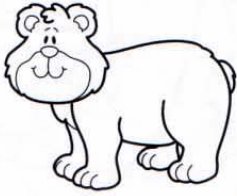
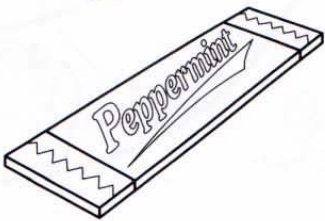

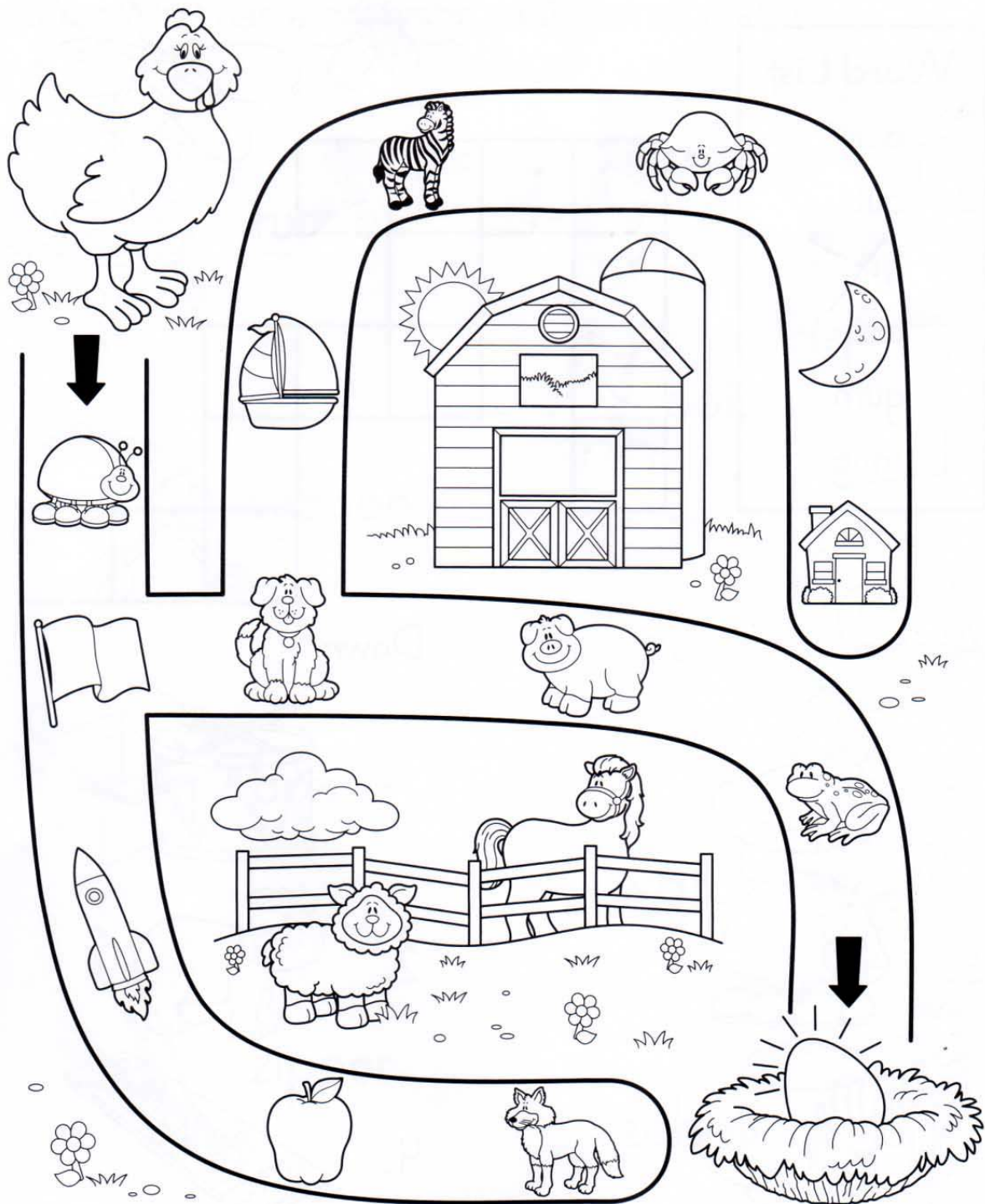

Down

1. 
2. 
4. 

Draw a line along the path with pictures whose names **end** with the **g** sound to help the hen find the egg.



Use the key to color the spaces with pictures whose names **begin** with the same letter sounds.

 orange	 yellow	 blue
 n	 j	 p

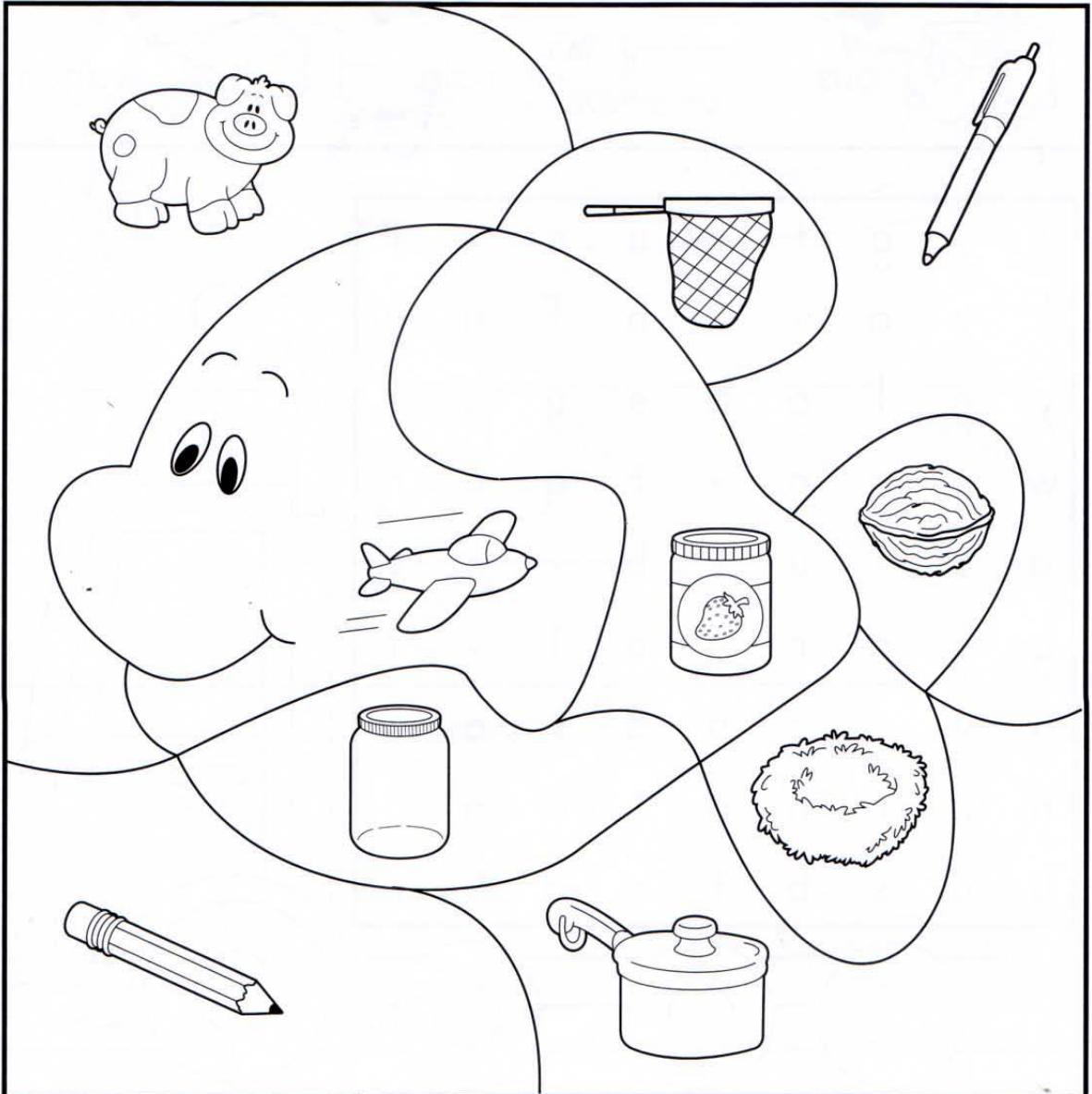

Circle the words from the word box in the puzzle below.



bike

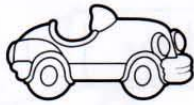

car

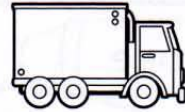

truck



boat



plane

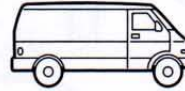

van

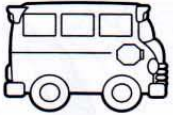

bus

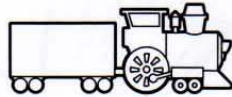

train



wagon

i y g t r u c k t
k v a v t h f n g
y p l a n e g b f
w p r n x t q n n
a u t u y b i k e
g g c r o o l v t
o y a c p a v c w
n n r n n t o n c
b u s b t r a i n

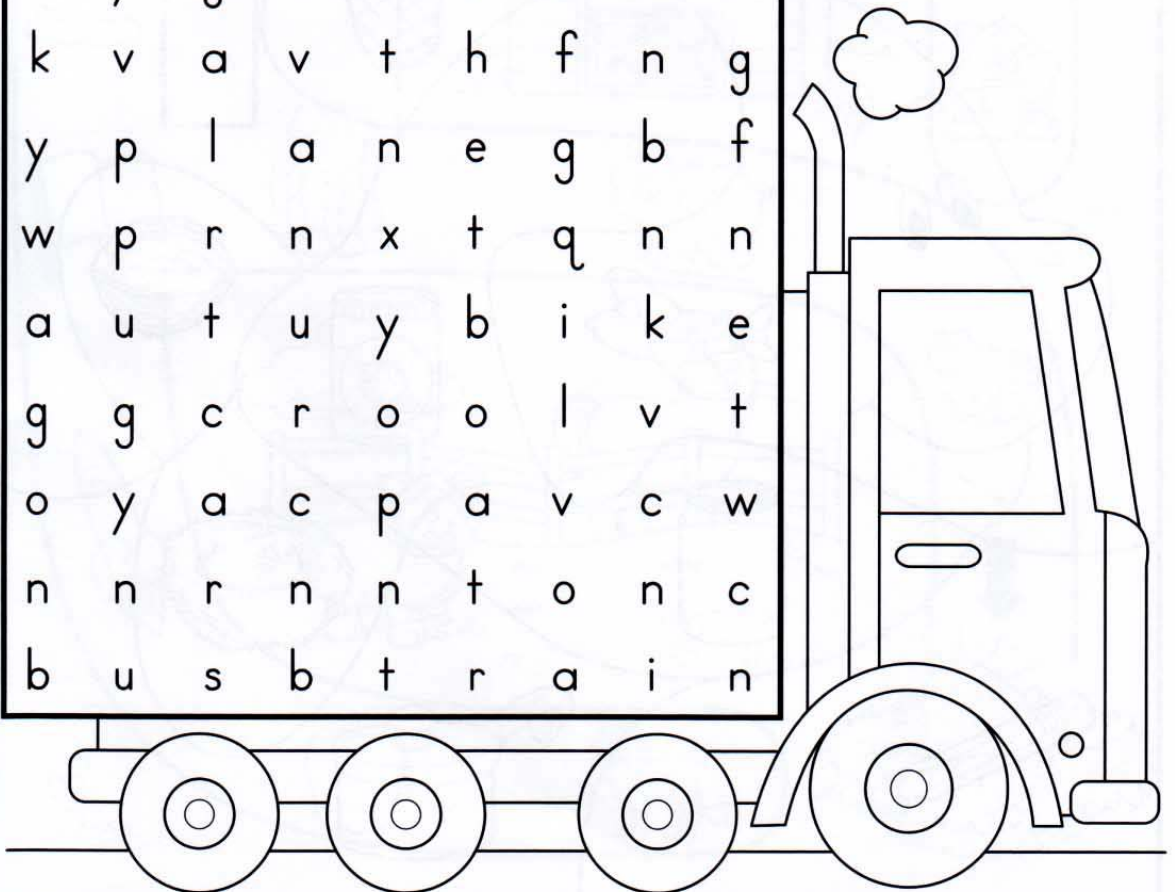

Use the secret code to solve the riddle.

Where do funny frogs sit?

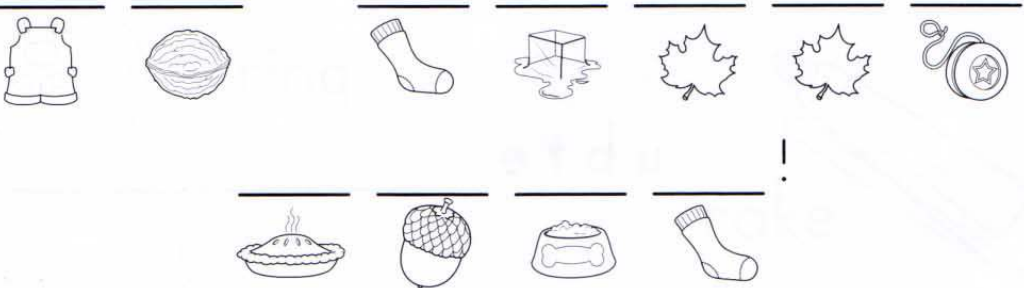
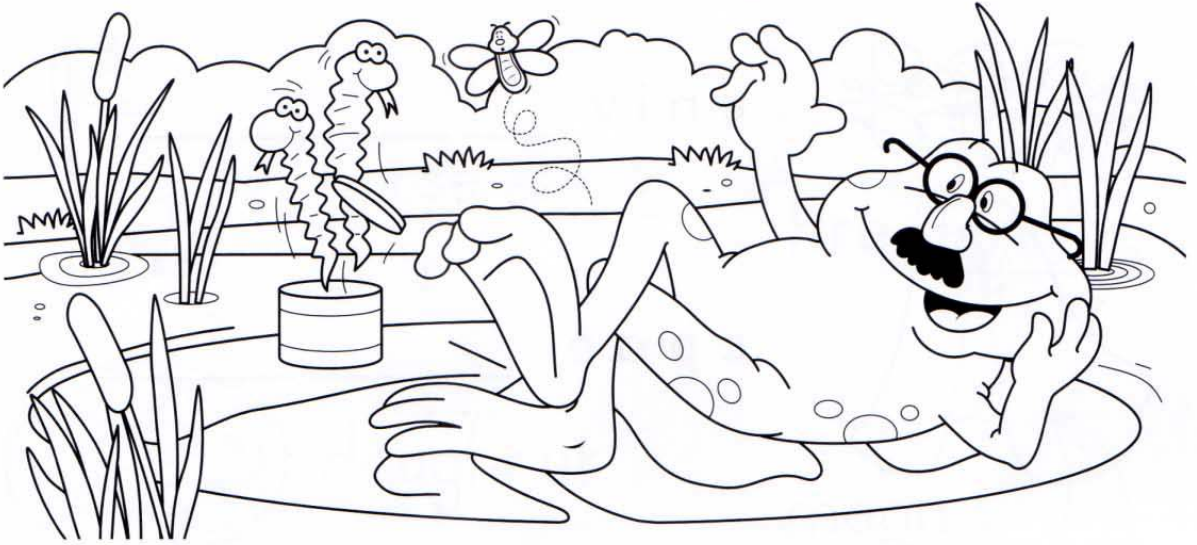

Secret Code

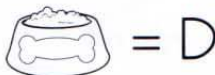
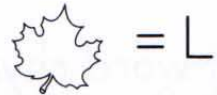
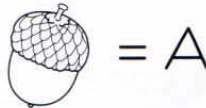
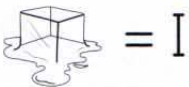
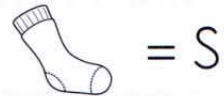
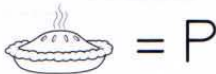

Unscramble each word and write it on the lines. Then, use the words to answer the questions.

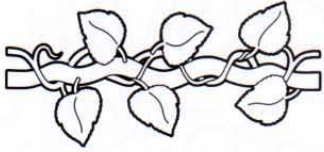

e n i v _____



c p a e _____

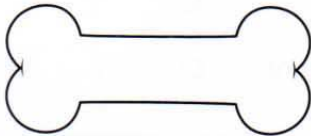

n b o e _____

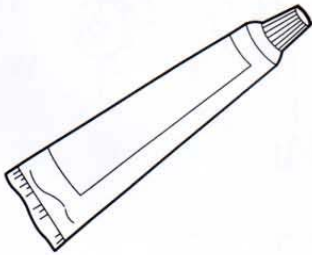

u b t e _____

What word rhymes with cube? _____

What word rhymes with tape? _____

What word rhymes with cone? _____

What word rhymes with nine? _____

Draw lines to match the words with the same **beginning** sound. Circle the picture that is left. It is the answer to the riddle: What nut has a hole in the middle?

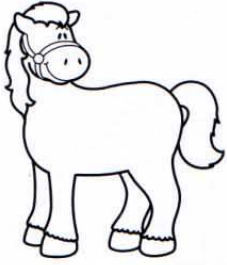

horse

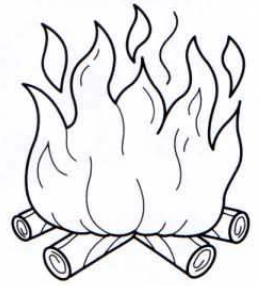

fire

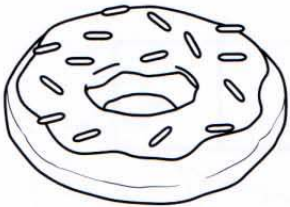

doughnut

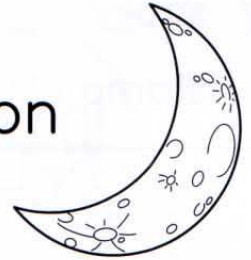

moon

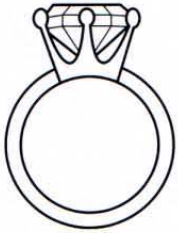

ring

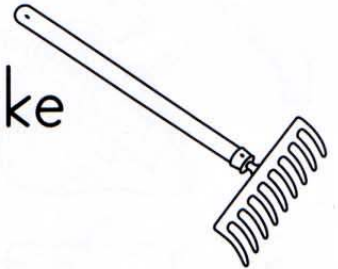

rake

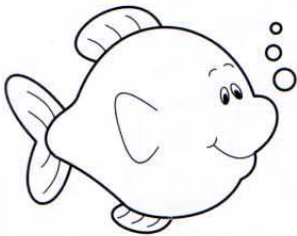

fish

hammer



mitten

Use the words from the word list to solve the crossword puzzle.

Word List

ham

hat

map

pan

sack

stamp

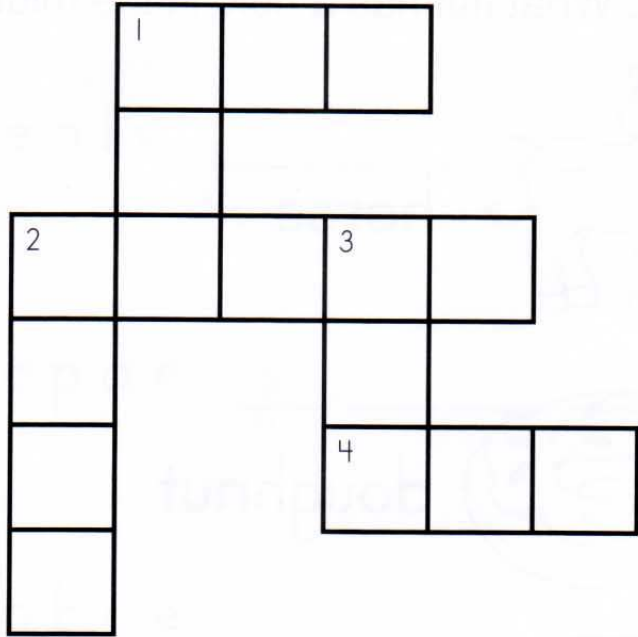

Across

1.

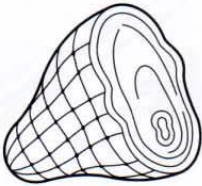

2.



4.

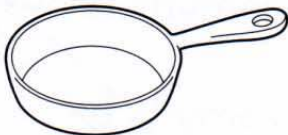

Down

1.



2.

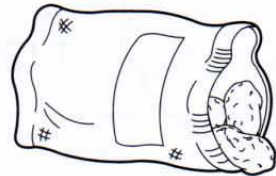



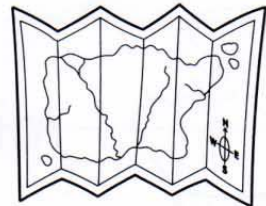

3.

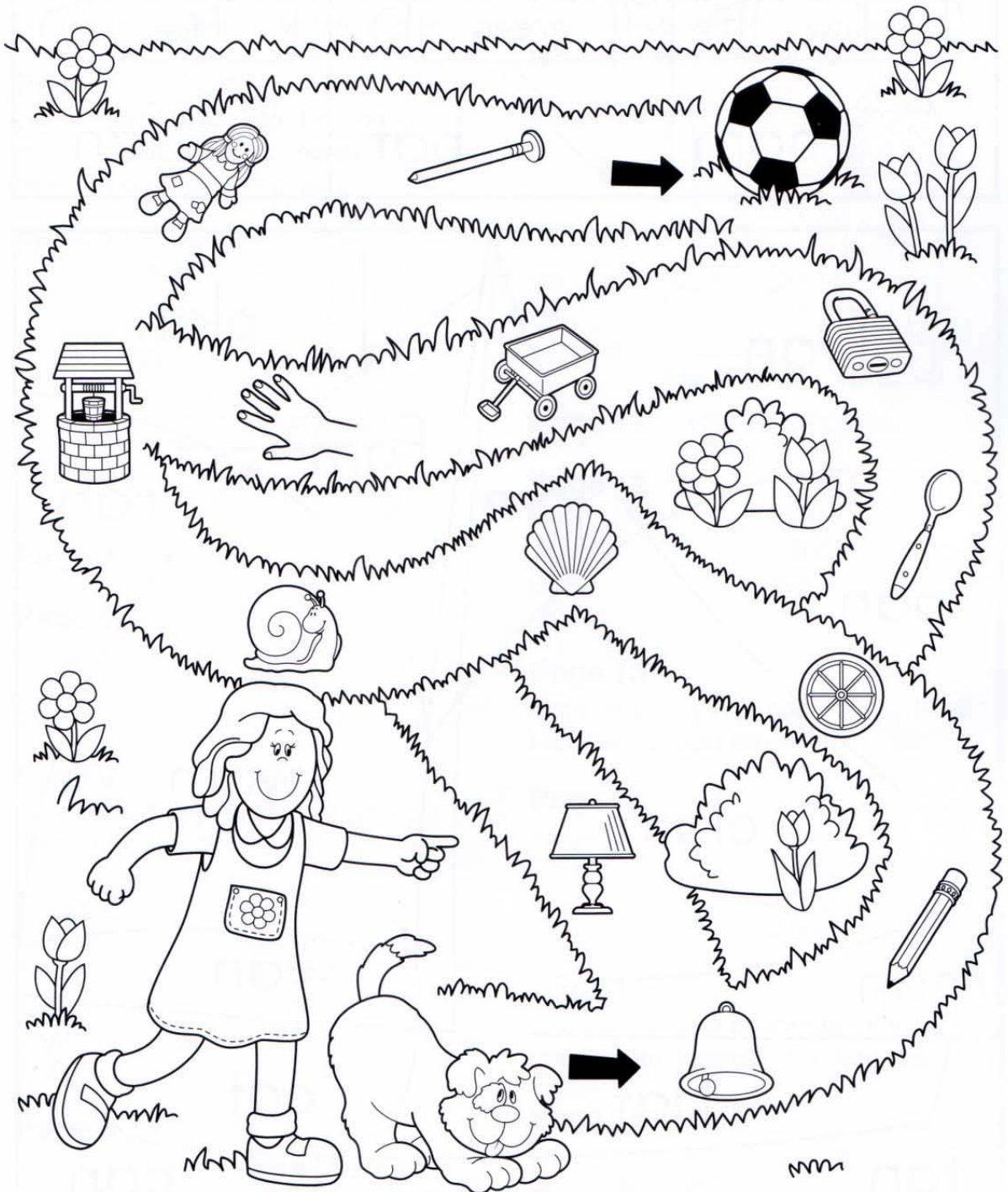

Draw a line along the path with pictures whose names **end** with the **I** sound to help the girl find the ball.

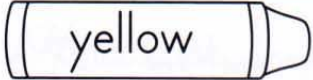
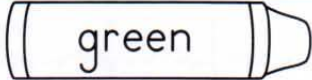

Use the key to color the spaces with words that **rhyme**.

 yellow	 green	 blue
 ham	 bat	 fan

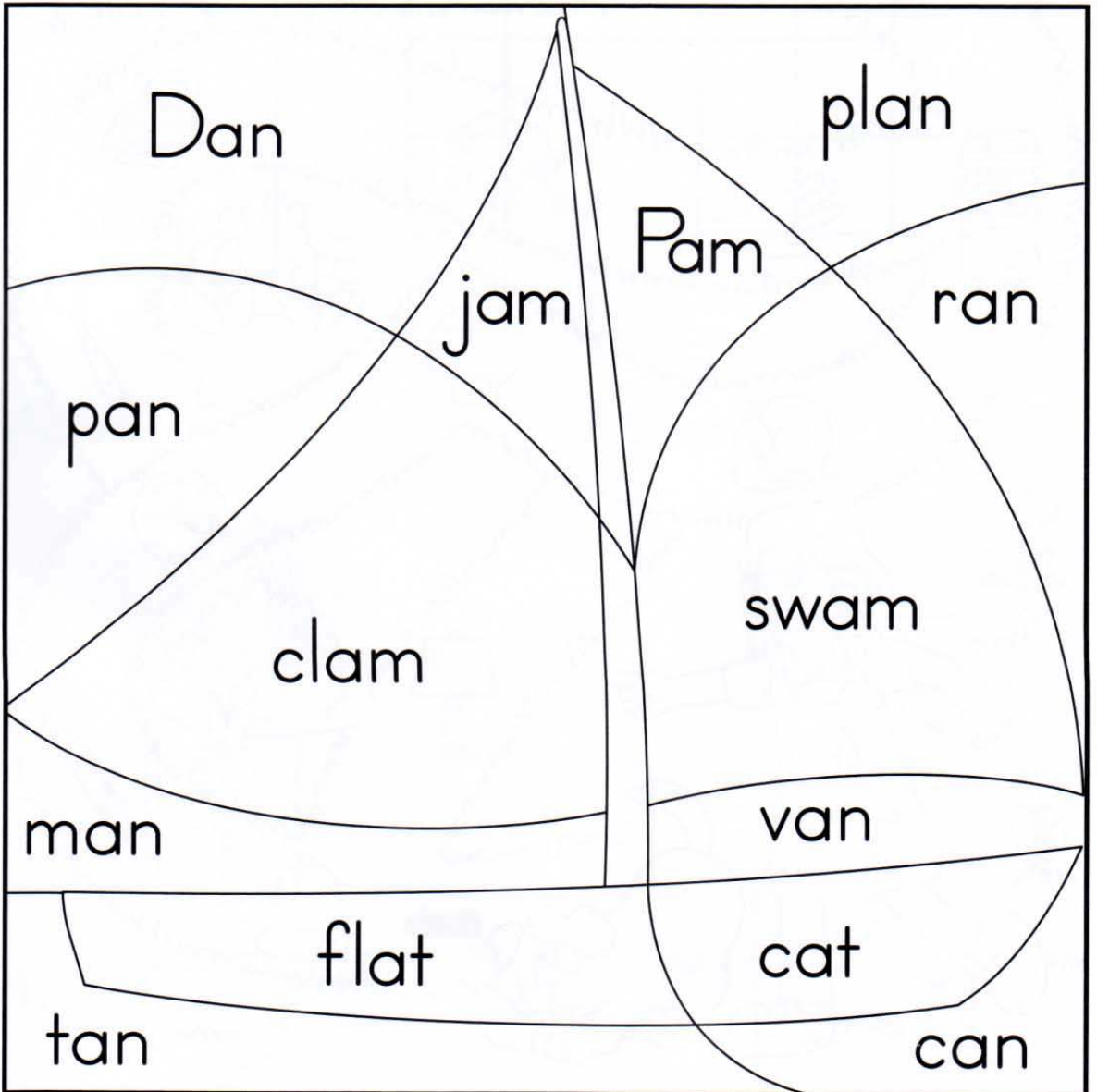

Dan

pan

jam

clam

man

flat

tan

plan

Pam

ran

swam

van

cat

can

Circle the number words from the word box in the puzzle below.

0 zero	3 three	6 six	9 nine
1 one	4 four	7 seven	10 ten
2 two	5 five	8 eight	

1
2
3
4
5
6

Use the secret code to solve the riddle.

What kind of beans do not grow in a garden?

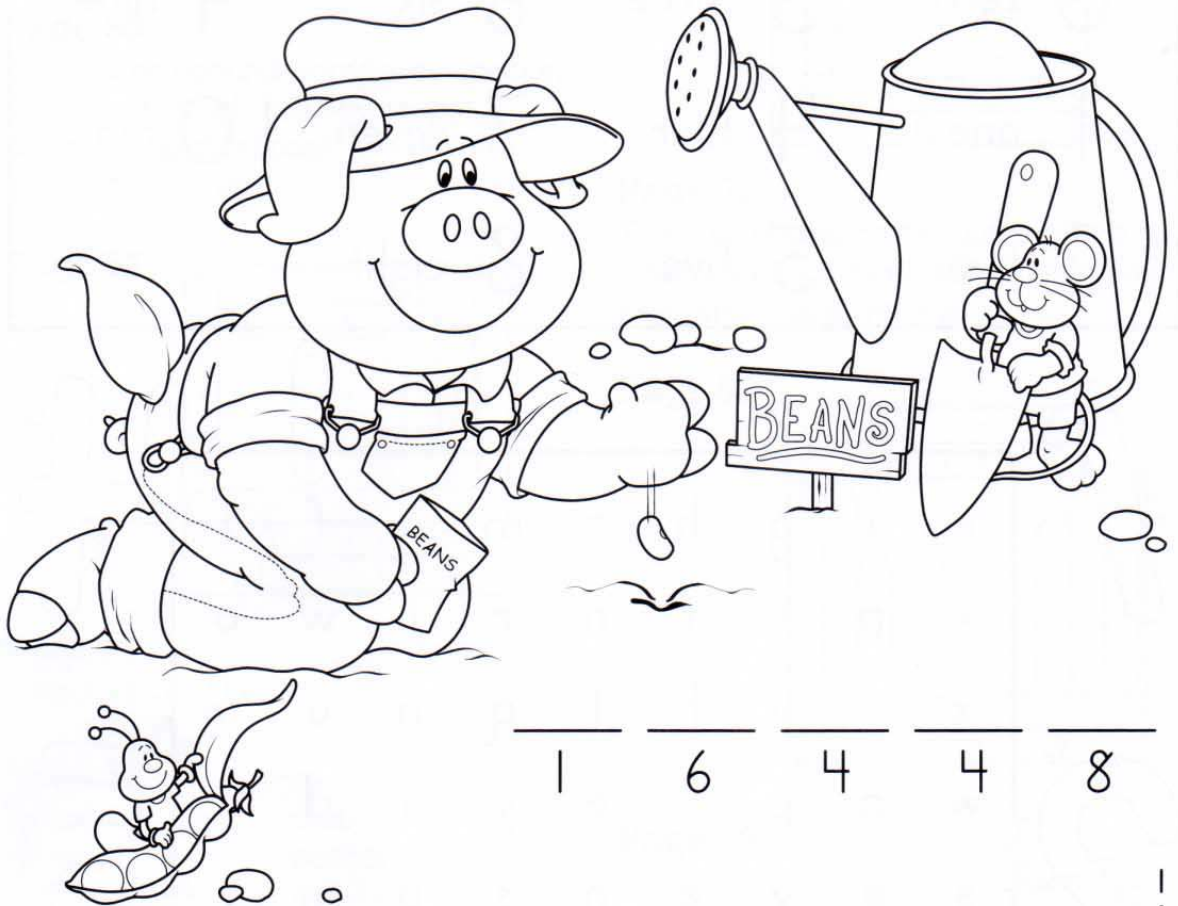

Secret Code

4 = L

8 = Y

6 = E

2 = A

7 = S

1 = J

3 = N

5 = B

Unscramble each word and write it on the lines. Then, write the circled letters in order to answer the riddle.



t r a s _____ () _____

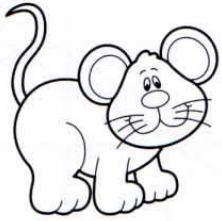

e o s u m _____ () _____

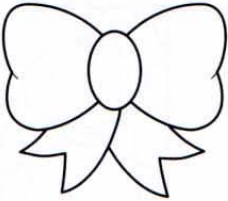

o b w _____ () _____

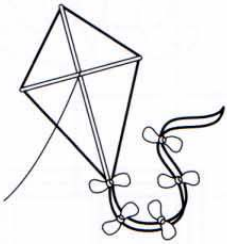

t k i e _____ () _____



g l i r _____ () _____

What gets wetter the more it dries?

a _____

Draw lines to match the words with the same **beginning** sound. Circle the picture that is left. It is the answer to the riddle: What kind of bow cannot be tied?



sock

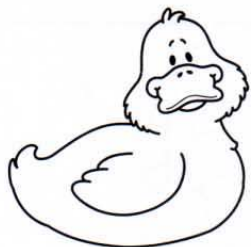

duck



nest



rainbow

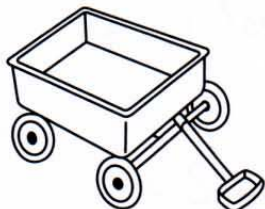

wagon

nail

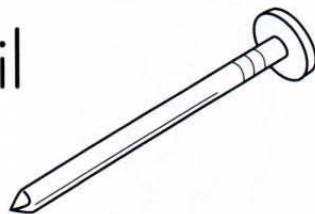

dog



window

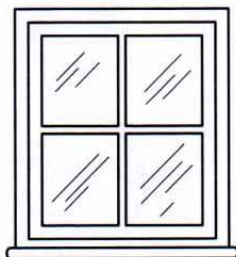

saw



Use the words from the word list to solve the crossword puzzle.

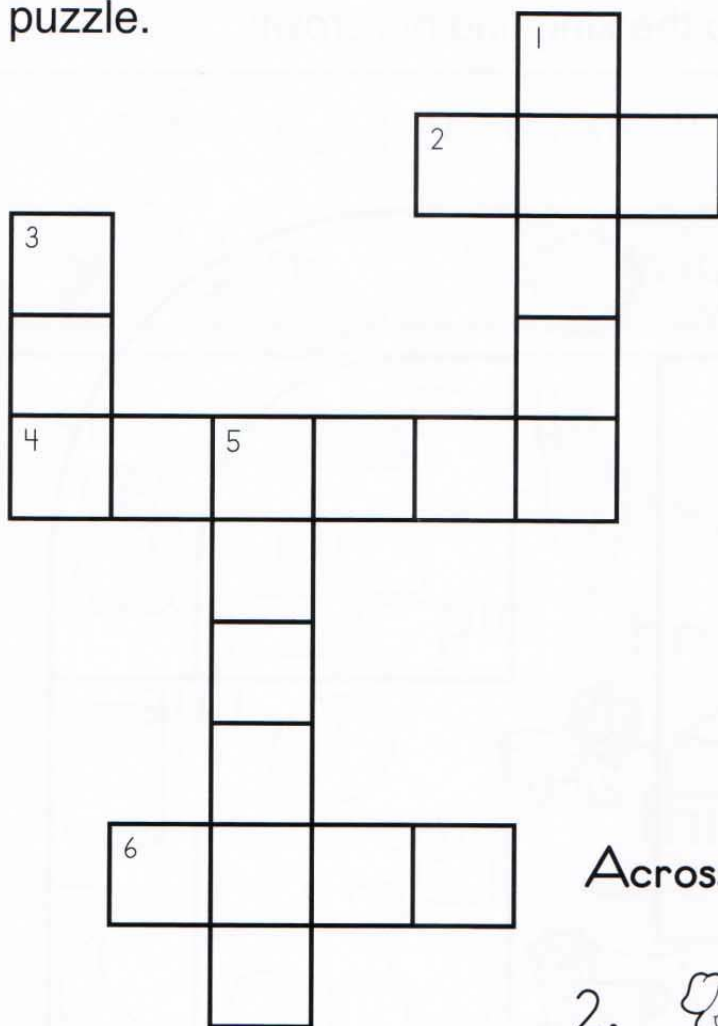

Word List

cat
dog
fish
mouse
rabbit
turtle

Across

Down

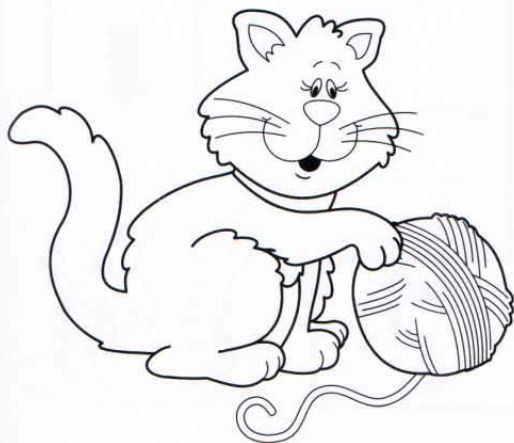
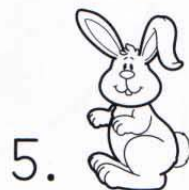
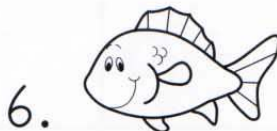
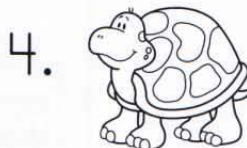
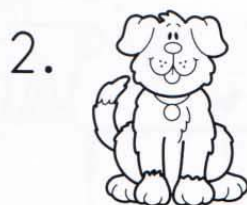

Circle the words from the word box in the puzzle below.

birthday

friends

hat

cake

fun

present

candles

games

sing



Use the secret code to solve the riddle.

How do bees get to school?



4

1

2

“

”!

6

8

5

5



Secret Code

8 = U

6 = B

1 = N

9 = S

2 = A

3 = M

5 = Z

4 = O

Unscramble each word and write it on the lines. Then, use the words to finish the sentences below.



p y u p p _____



z p r i e _____

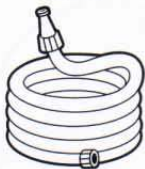

s o h e _____

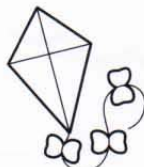

t e k i _____



g e c a _____

1. The _____ is in the garden.

2. Sam won first _____.

3. We flew a _____ today.

4. The bird was in the _____.

5. The _____ is very cute.

Draw lines to match words that go together to make compound words. Use the compound words to finish the sentences below.

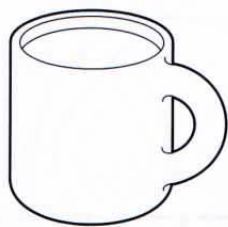

cup

ball

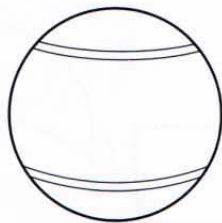

foot

bell

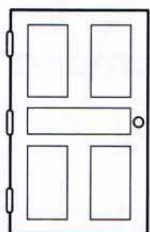

door

cake



doll

house

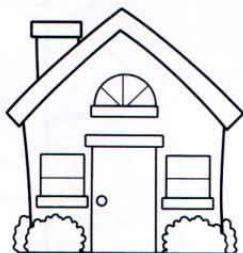

1. We played _____ outside.
2. Pam had a _____ on her birthday.
3. Sara has a pretty pink _____.
4. Please ring the _____.

Use the words from the word list to solve the crossword puzzle.

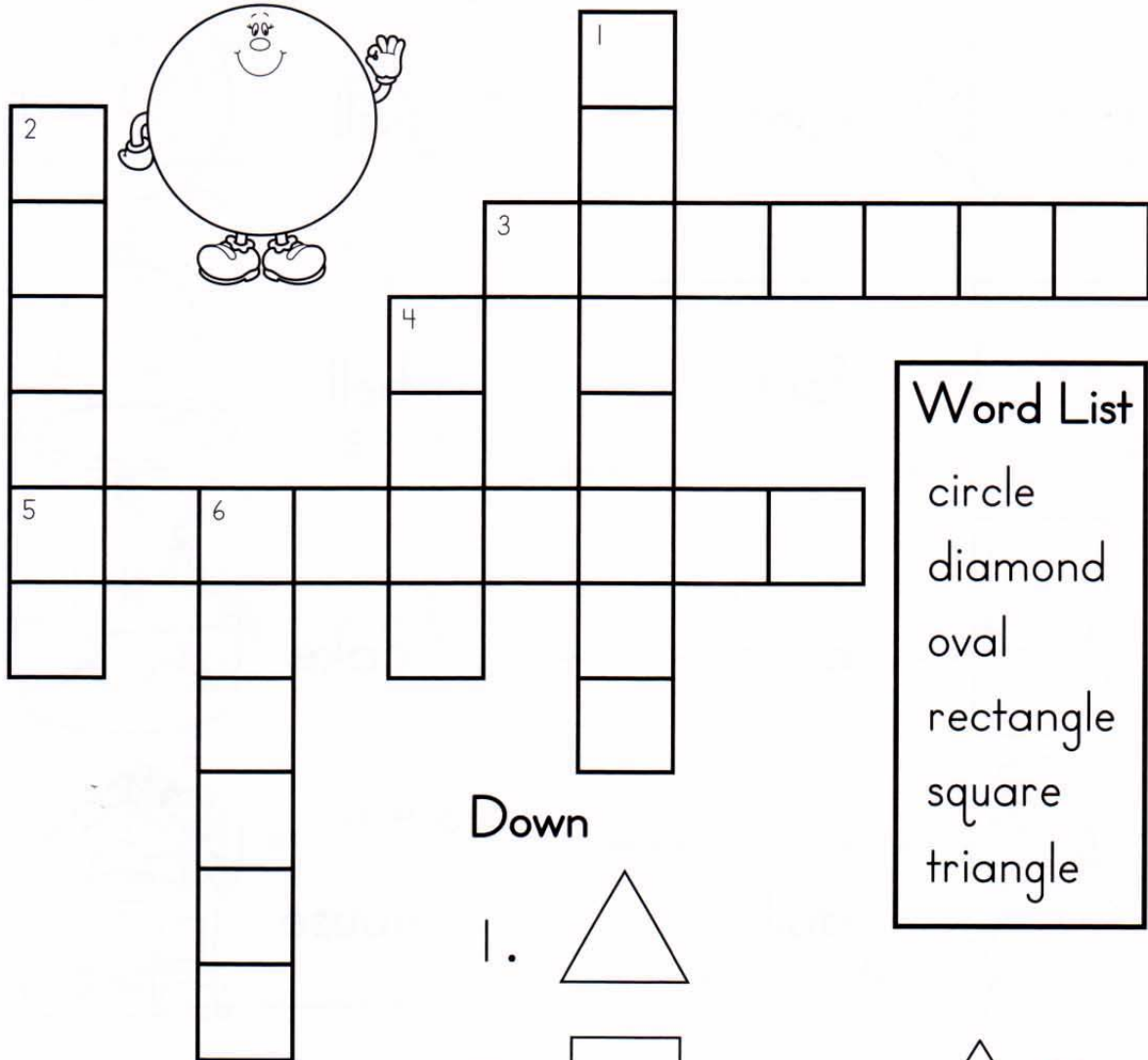
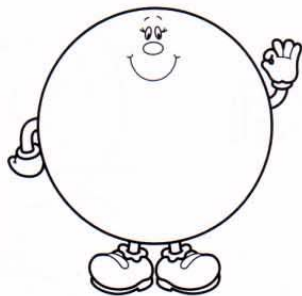

Word List
 circle
 diamond
 oval
 rectangle
 square
 triangle

Across

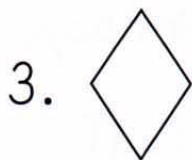



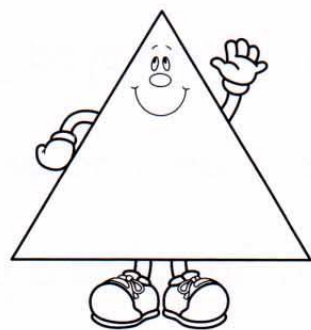

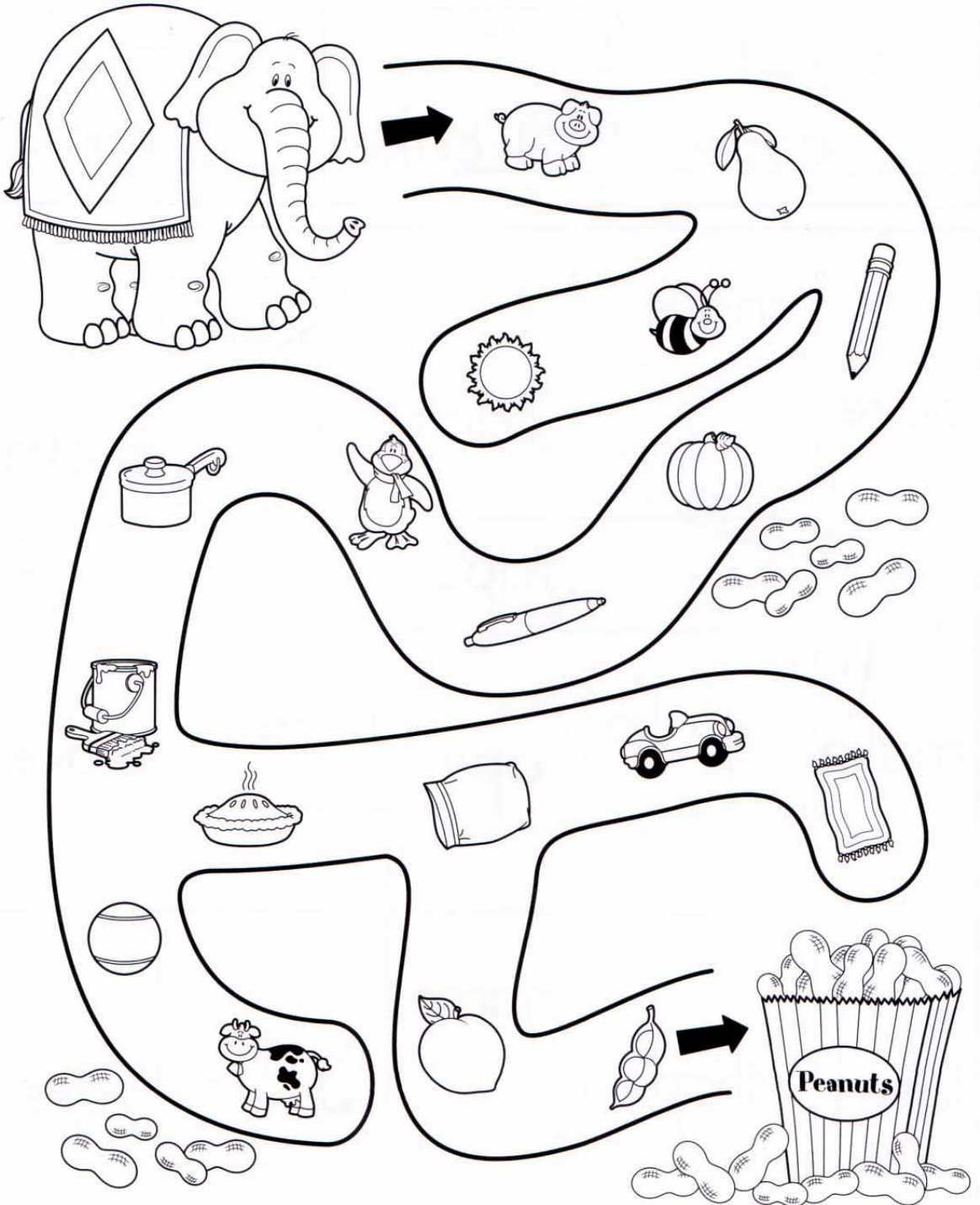

Down



Draw a line along the path with pictures whose names **begin** with the **p** sound to help the elephant find the peanuts.



Use the key to color the spaces with words that **rhyme**.

 blue	 yellow	 red
 cape	 cake	 game

	snake		same	
bake		came		shake
		tape		
make	take	ape	rake	wake
		name		
lake	shape	o	grape	fake

Use the secret code to solve the riddle.

What do ducks eat for a snack?

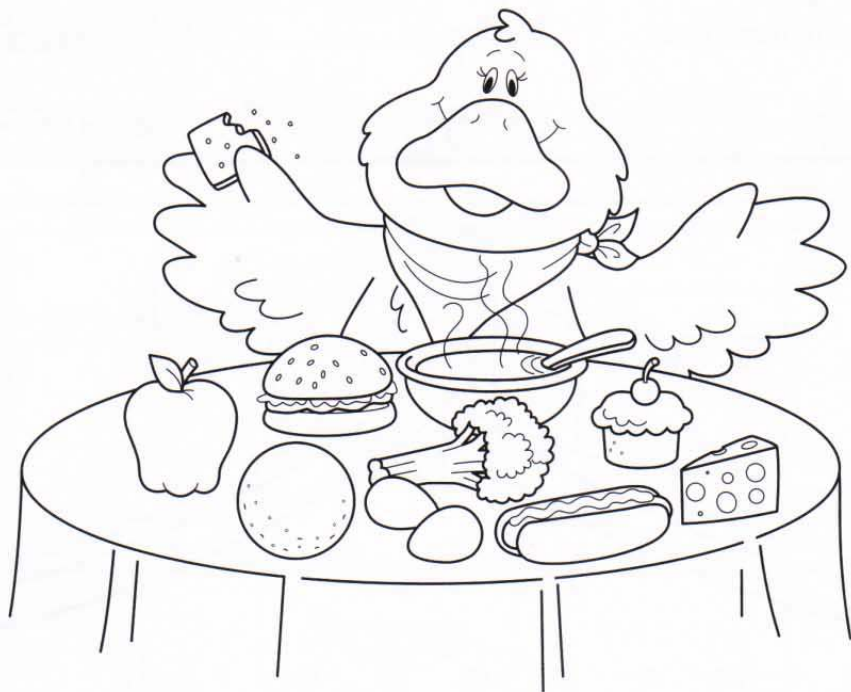

“ _____ ”
5 7 9 2 6 3 4 8 !

Secret Code

7 = U

5 = Q

2 = C

8 = S

9 = A

6 = K

4 = R

3 = E

Unscramble each describing word and write it on the lines. Then, write the circled letters in order to answer the riddle.

cute

happy

noisy

sleepy

funny

neat

pretty

h y a p p _____ () _____

f n n u y _____ () _____

s p l e e y _____ () _____

u t e c () _____

n s o i y _____ () _____

r e t p t y _____ () _____

a n e t () _____

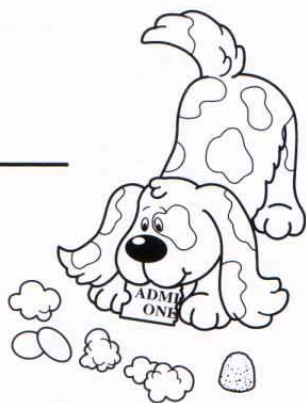

What do dogs eat at the movies?

“ _____ ” !
_____ !

Use the words from the word list to solve the crossword puzzle.

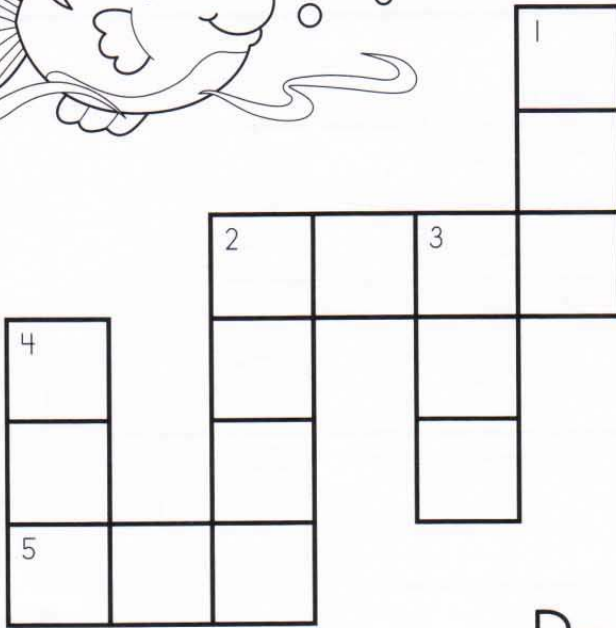
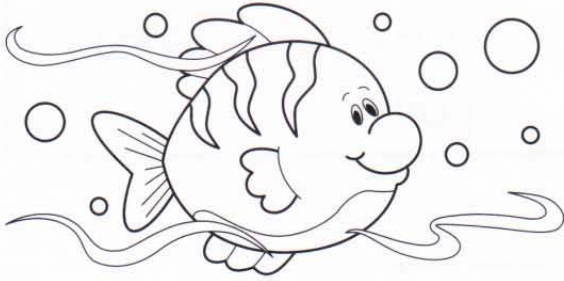

Word List

fin
 gift
 grin
 kit
 lip
 pin

Down

Across

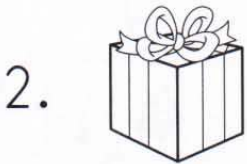

Draw a line along the path with pictures whose names **end** with the **r** sound to put the coin in the piggy bank.

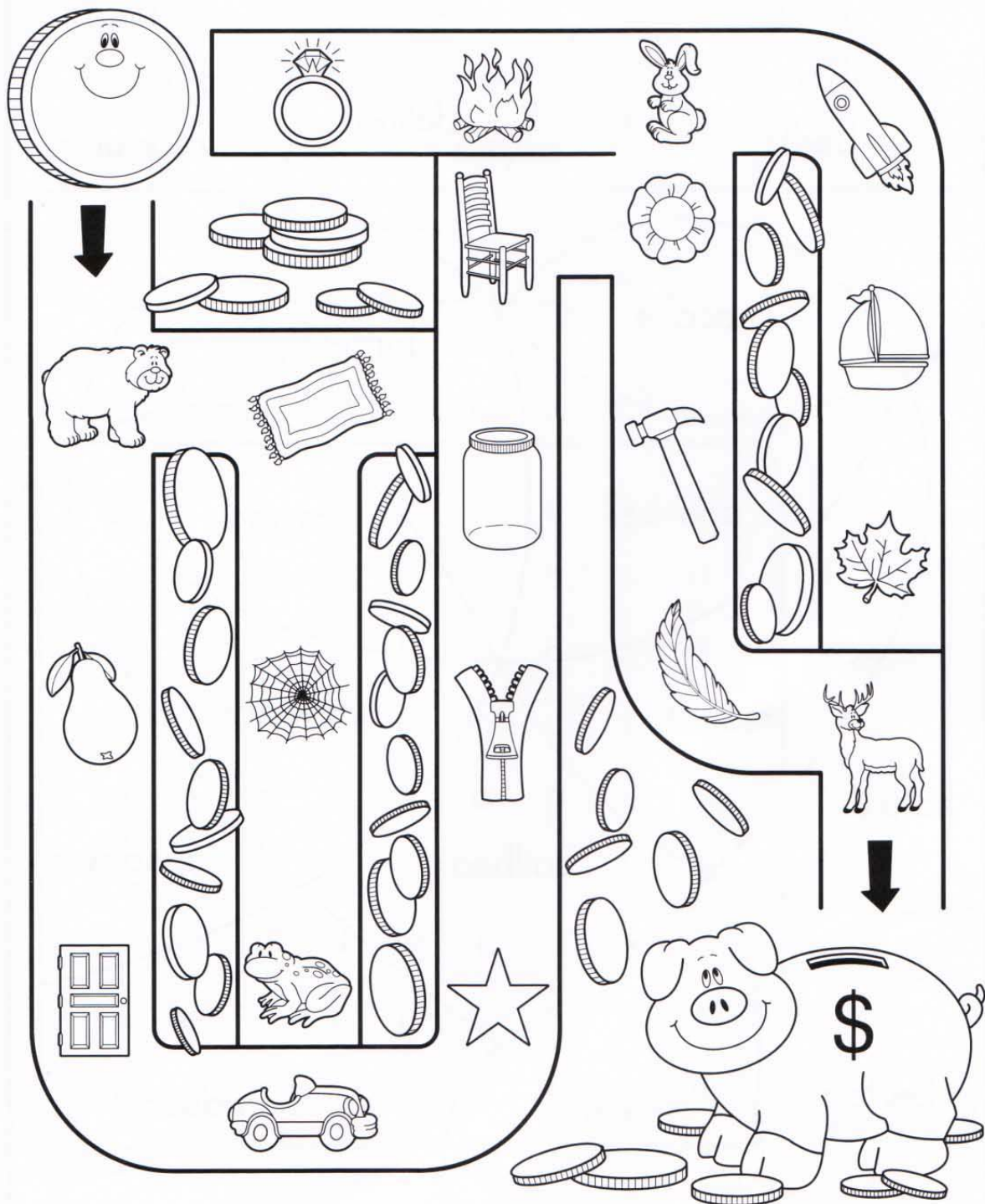

Use a red crayon to color each space that contains a real compound word.

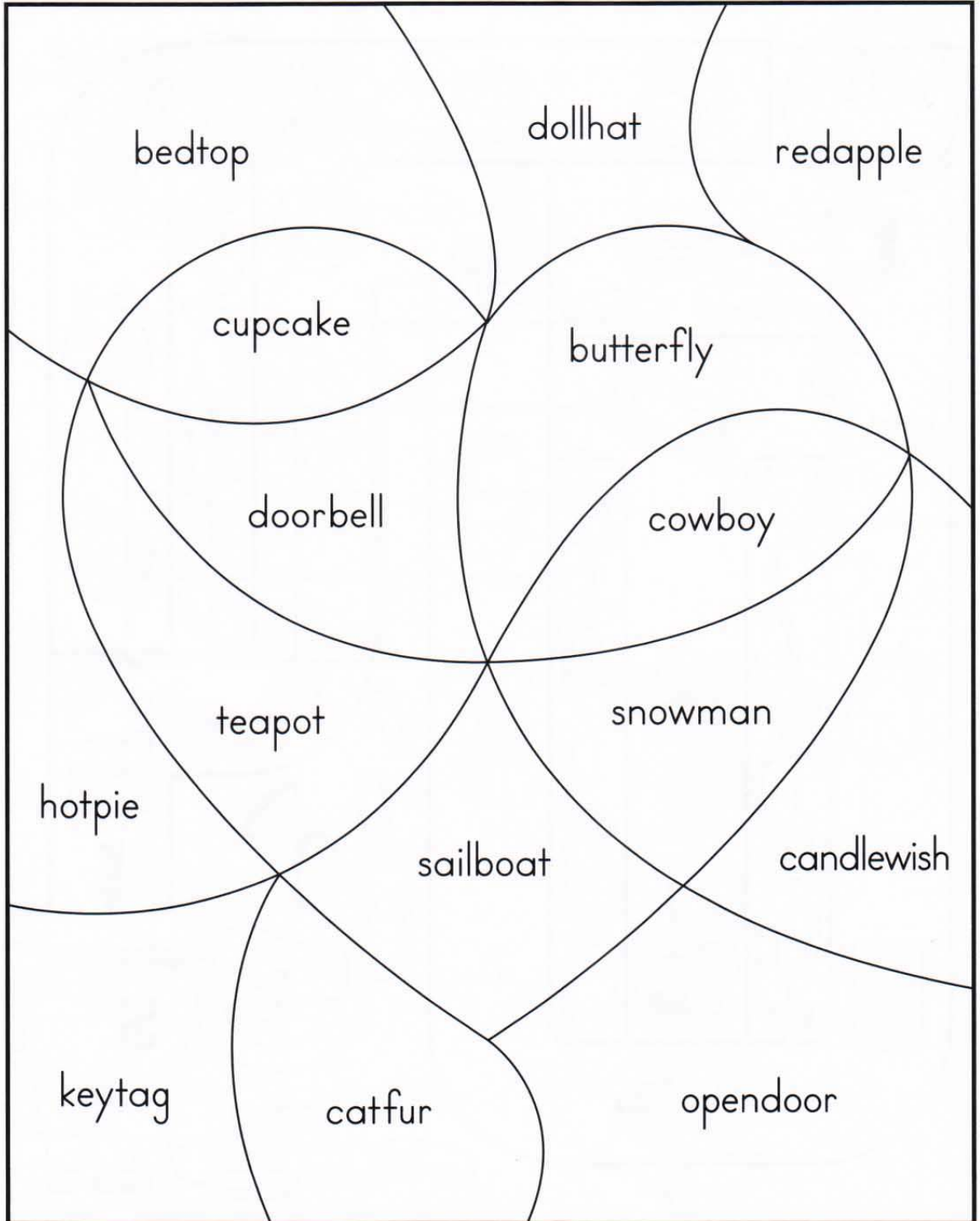

Circle the words from the word box in the puzzle below.

apple

juice

pizza

banana

lunch

sandwich

cookie

milk

soup

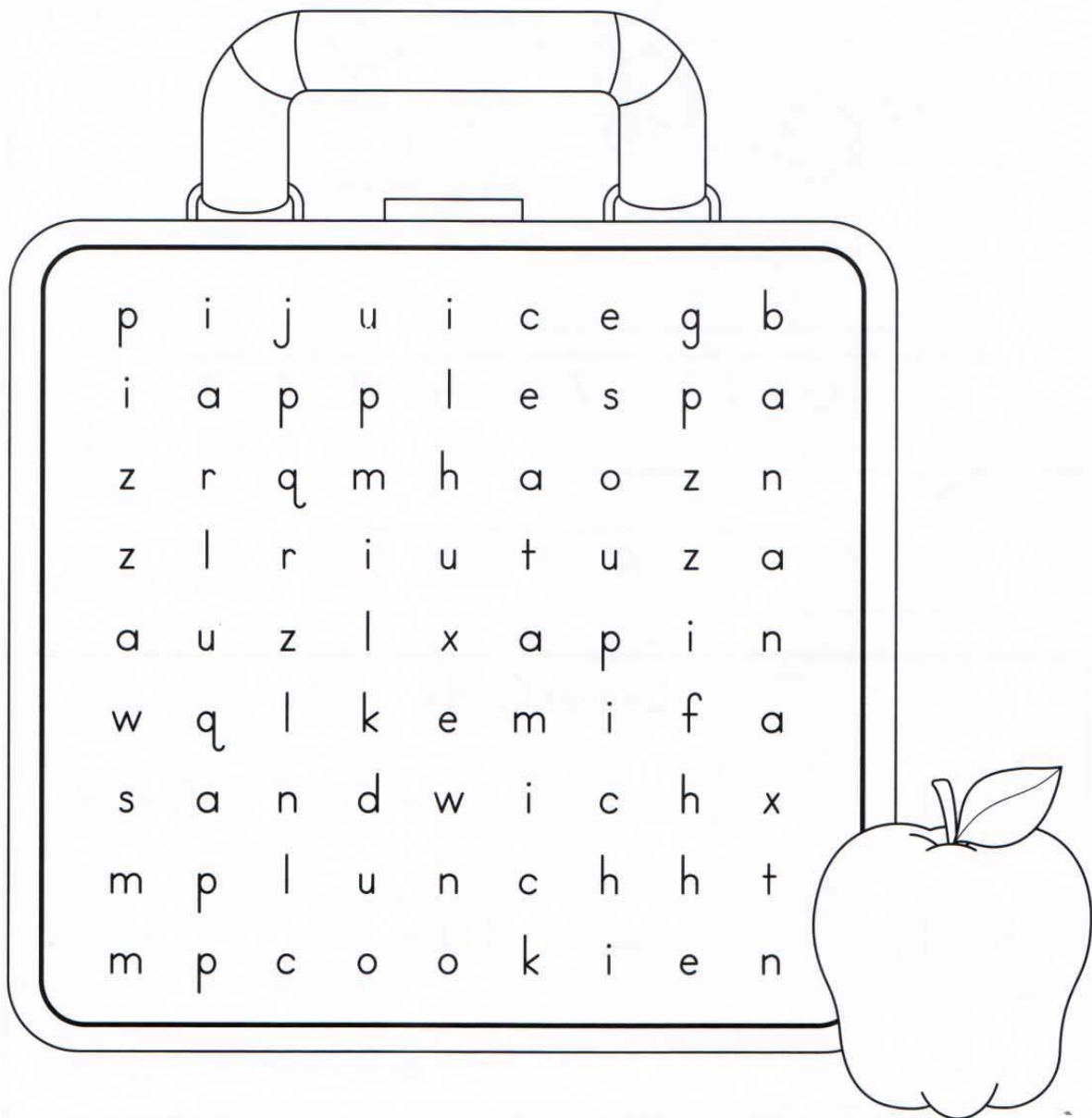

Use the secret code to solve the riddle.

What is a dog's favorite sport?



“

”

8 10 12 7 14 10 9 —

8 6 2 2 !

Secret Code

14 = U

12 = S

1 = D

8 = B

5 = N

6 = A

10 = I

7 = C

11 = J

2 = L

9 = T

3 = Y

Unscramble each animal name and write it on the lines.
Write the circled letters in order to find the secret word.

crab

gull

oyster

shark

dolphin

lobster

seahorse

steroy

bcra



blostre

ashorse

ndlphio

lgul

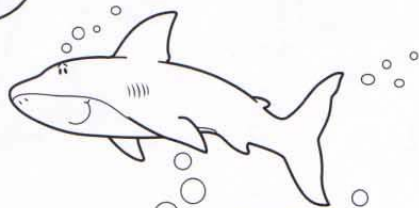

ksarh

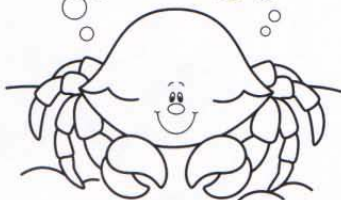

Secret Word

Circle the words from the word box in the puzzle below.

desk

notebook

school

homework

paper

student

learn

pencil

teacher

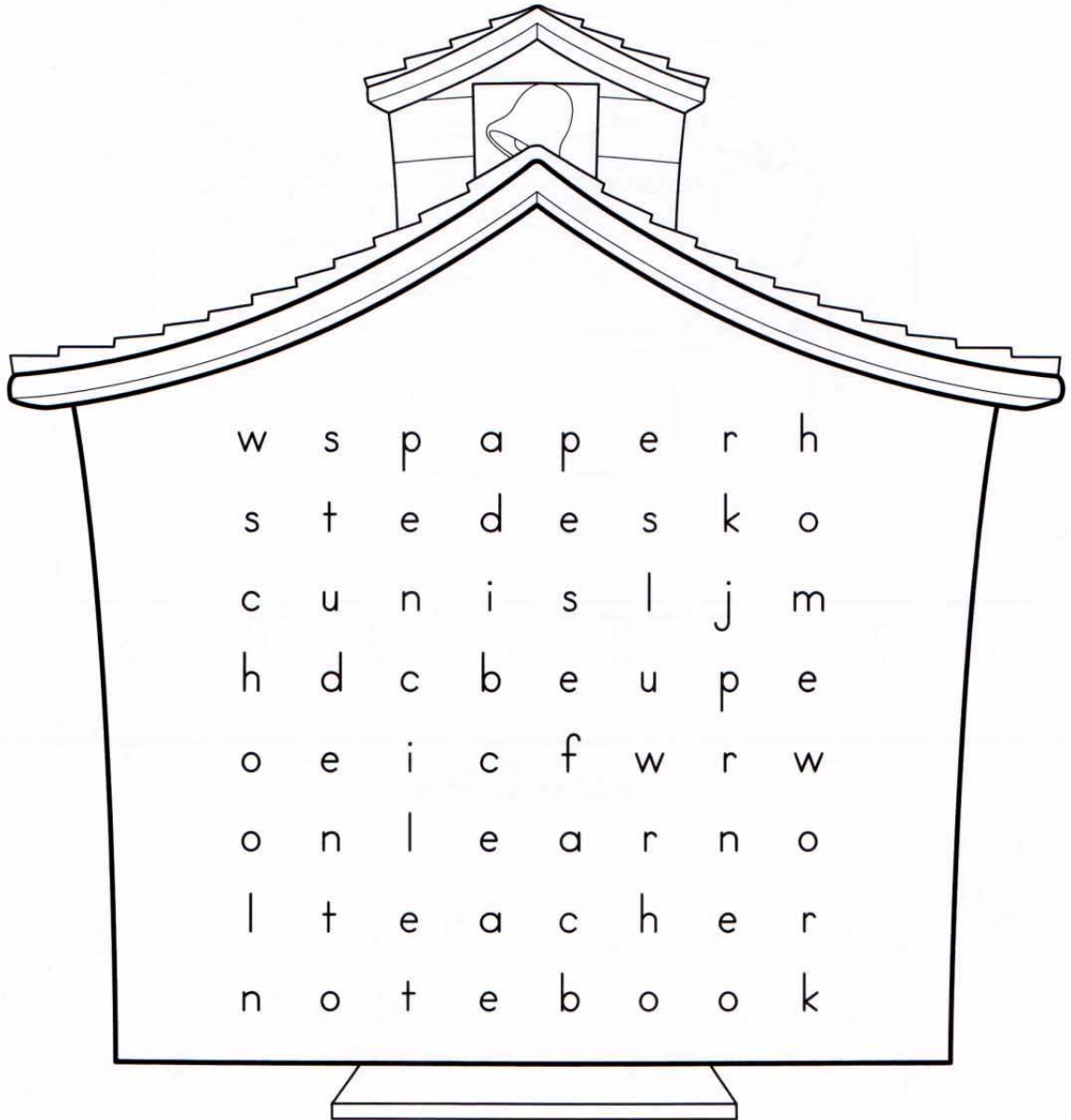

Use the words from the word list to solve the crossword puzzle.

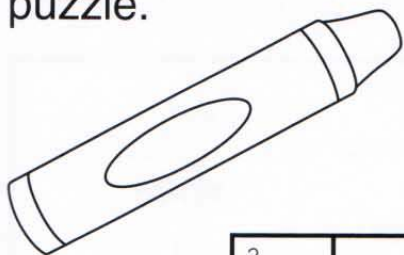

Word List

- blue
- green
- orange
- purple
- red
- yellow

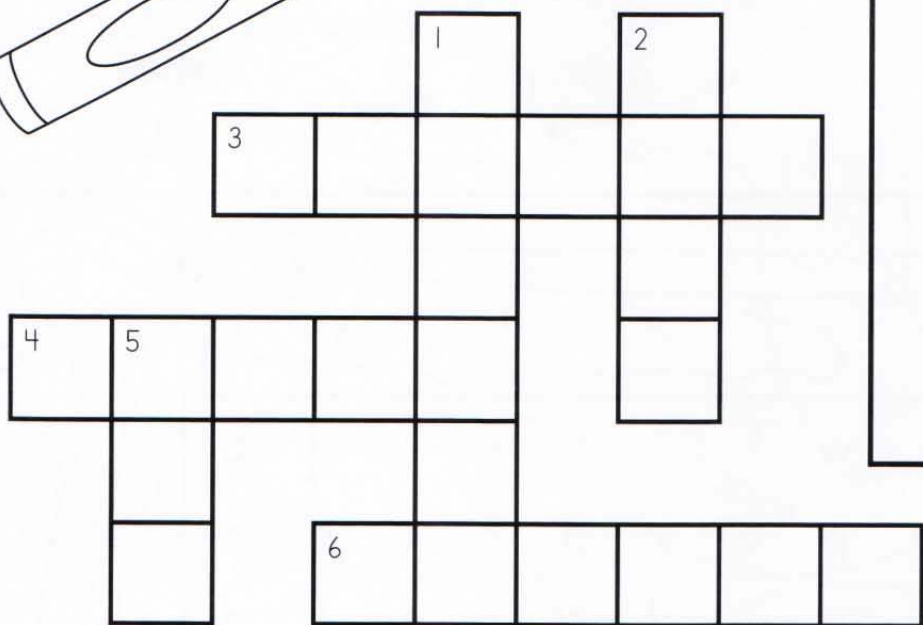

Across

- 3. The grapes are _____.
- 4. The leaf is _____.
- 6. The sun is _____.

Down

- 1. The pumpkin is _____.
- 2. My jeans are _____.
- 5. The apple is _____.

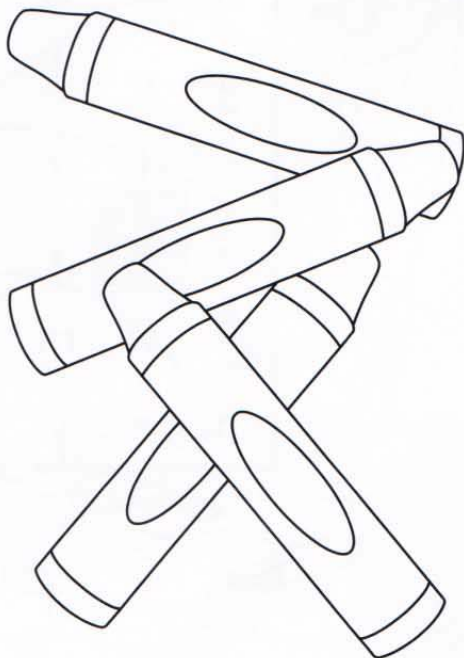

Circle the color words from the word box in the puzzle below.

black

green

red

blue

orange

white

brown

purple

yellow

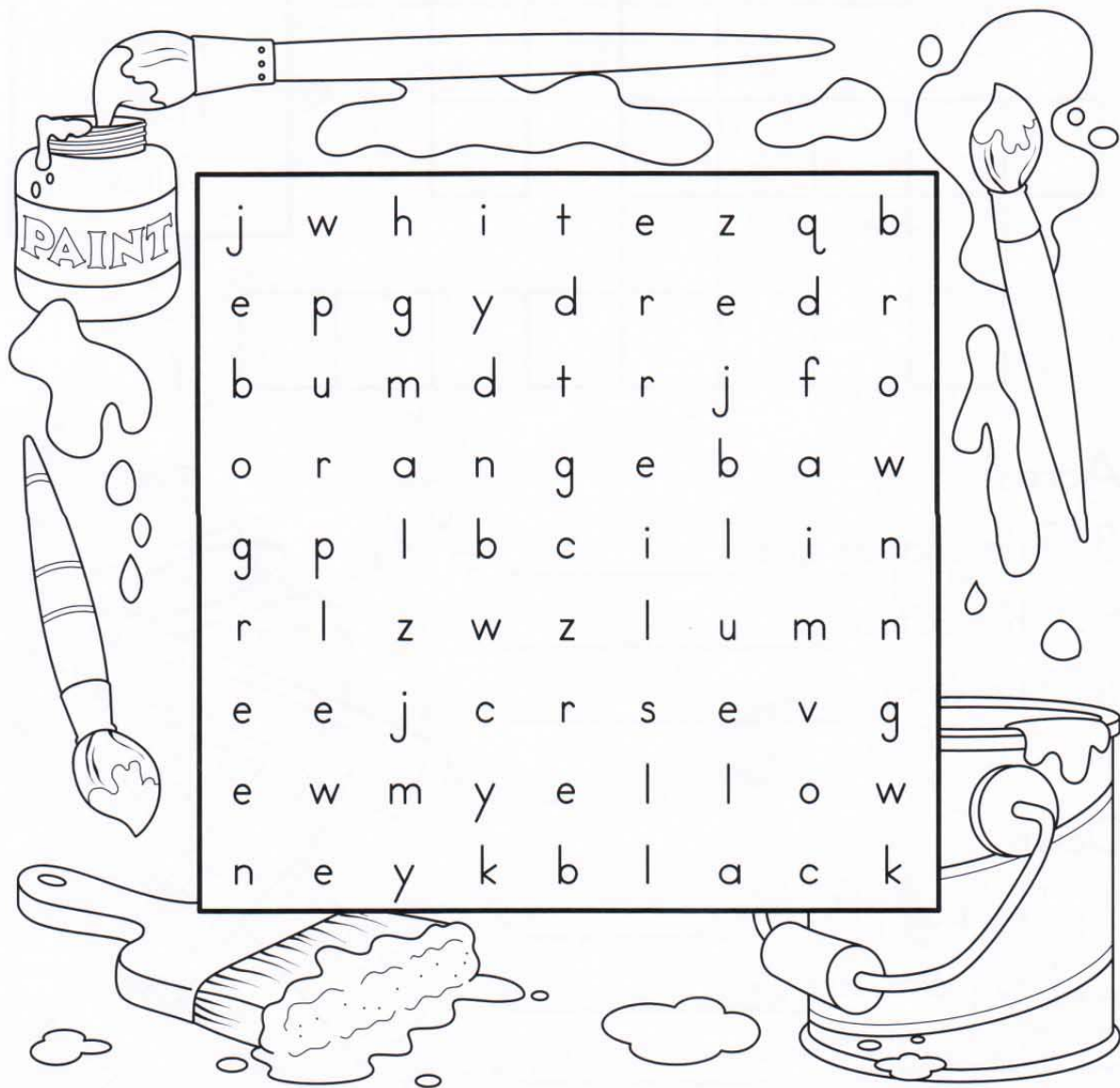

j	w	h	i	t	e	z	q	b
e	p	g	y	d	r	e	d	r
b	u	m	d	t	r	j	f	o
o	r	a	n	g	e	b	a	w
g	p	l	b	c	i	l	i	n
r	l	z	w	z	l	u	m	n
e	e	j	c	r	s	e	v	g
e	w	m	y	e	l	l	o	w
n	e	y	k	b	l	a	c	k

Draw a line along the path with pictures whose names **begin** with the **w** sound to help the boy find his wagon.

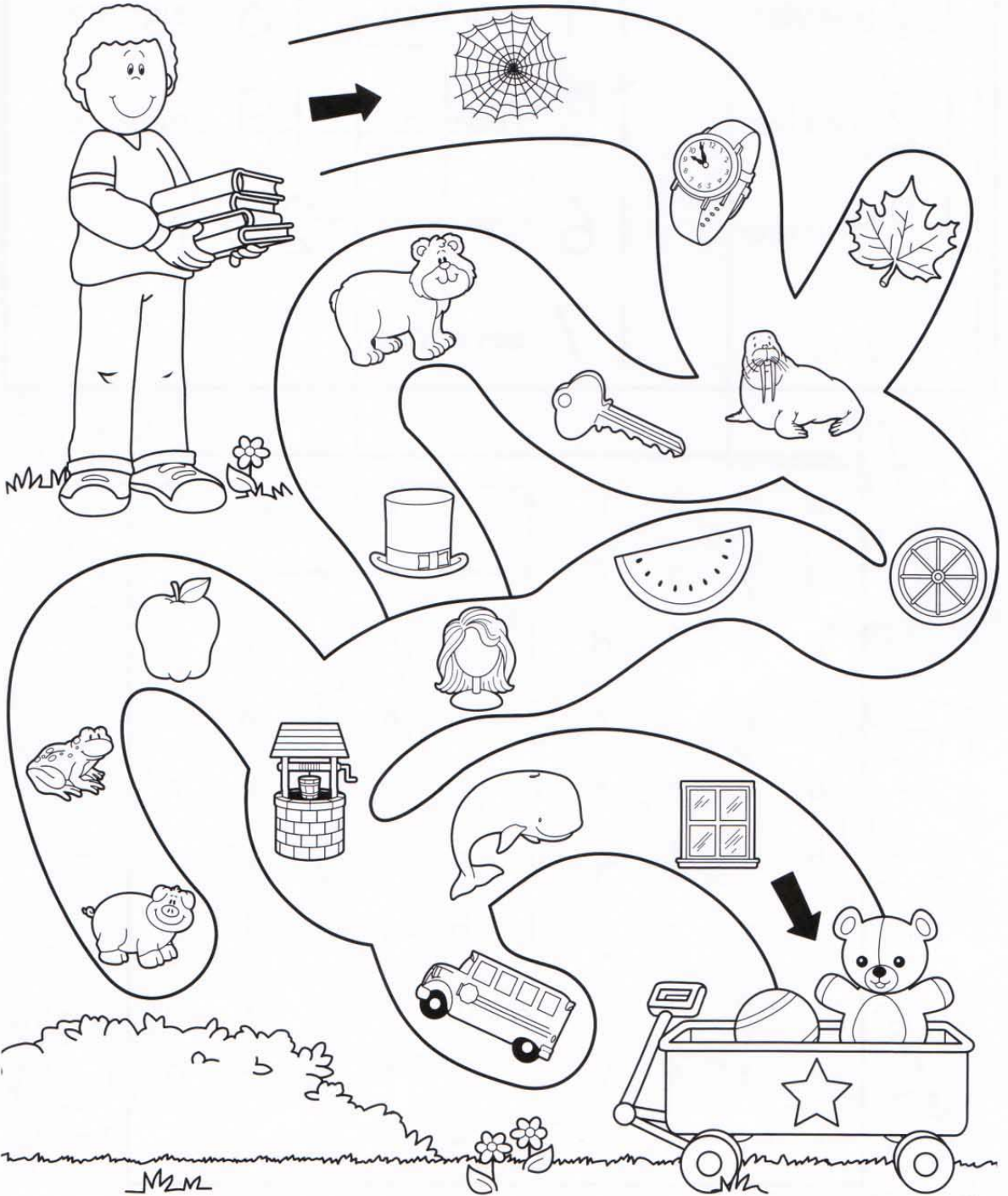

Circle the number words from the word box in the puzzle below.

11	eleven	14	fourteen	18	eighteen
12	twelve	15	fifteen	19	nineteen
13	thirteen	16	sixteen	20	twenty
		17	seventeen		

4

7

5

8

6

9

b	t	h	i	r	t	e	e	n	f
d	y	s	i	x	t	e	e	n	o
e	t	l	d	l	u	h	e	t	u
i	w	f	z	j	l	e	f	w	r
g	e	e	k	h	b	r	i	e	t
h	l	l	q	l	o	z	f	n	e
t	v	e	j	l	b	u	t	t	e
e	e	v	n	a	m	o	e	y	n
e	s	e	v	e	n	t	e	e	n
n	i	n	e	t	e	e	n	n	b

Use the word from the word list that is the opposite of each clue to solve the crossword puzzle.

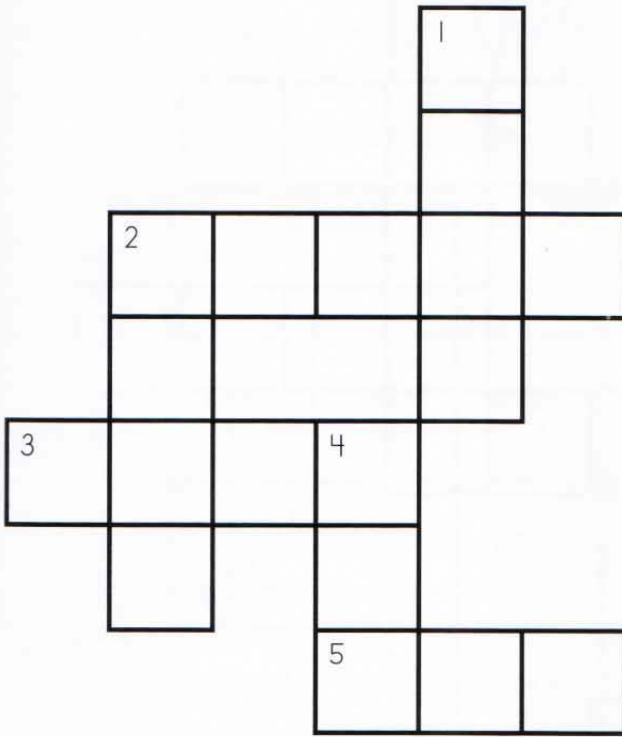

Word List

cold
down
new
small
stop
wet

Across

- 2. big
- 3. up
- 5. dry

Down

- 1. hot
- 2. go
- 4. old

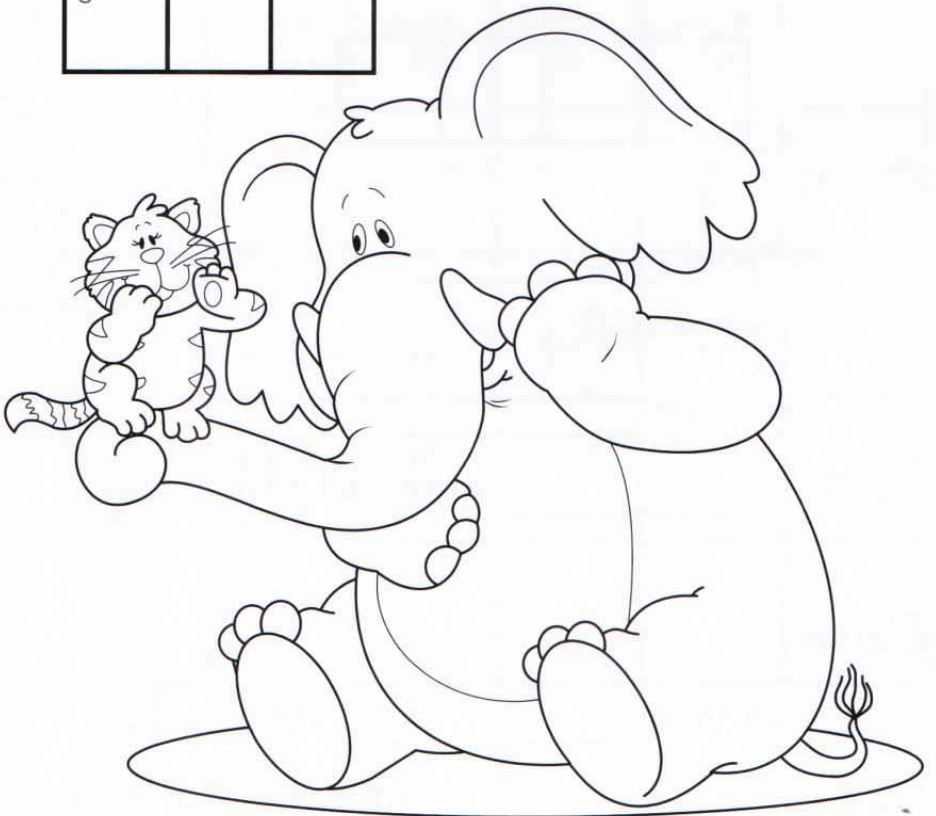

Use the words from the word list to solve the crossword puzzle.

Word List	
arms	hair
ears	hands
eyes	legs

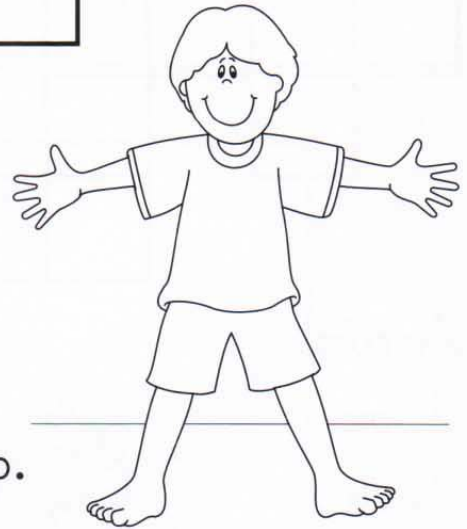
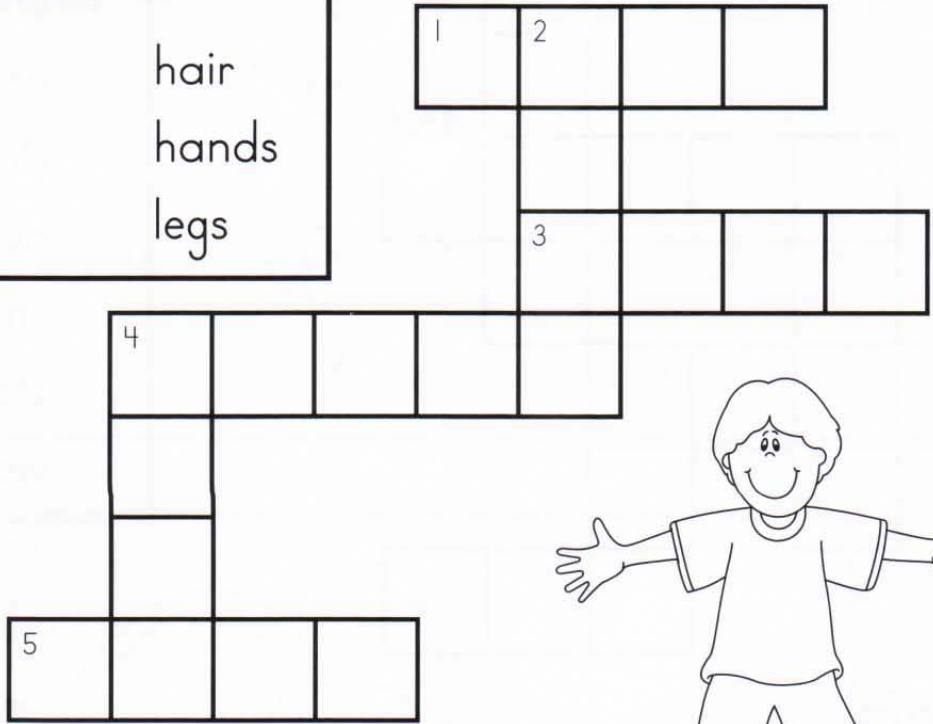

Across

1. Use your _____ to jump.
3. You hear with your _____.
4. Clap your _____.
5. Her _____ were full of books.

Down

2. Open your _____ and look.
4. Your _____ can be short or long.

Word Puzzles and Games: Grades K-1 Answer Key

Page 1

The path should go through the ball, box, boat, book, balloon, bell, bat, and bee.

Page 2

yellow: bear, book, box, bell, balloon

red: mop, mitten, map, mouse

blue: lemon, lock, lamp, lion

Page 3

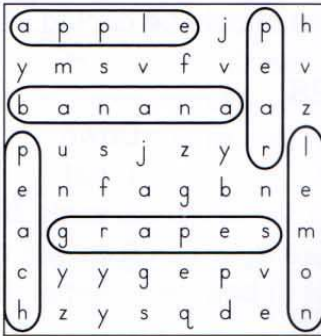

Page 4 AT A "HOOT"EL!

Page 5

cat	coat
log	drum
ball	a comb

Page 6

pig-hill; crab-cap; mop-frog; sun-bug
Bed should be circled.

Page 7

Across	Down
1. pen	2. nest
4. sled	3. bell
5. jet	
6. leg	

Page 8

The path should go through the desk, doll, dinosaur, duck, door, and deer.

Page 9

yellow: ring, rake, rocket, rope, rainbow, rug

orange: web, wagon

red: hammer, horn, hat, hand

Page 10

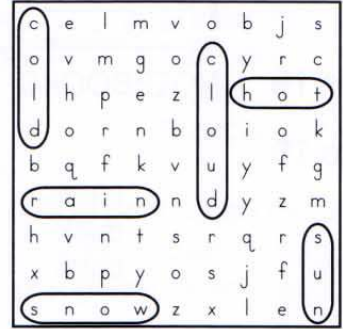

Page 11 HOPSCOTCH

Page 12

door	bird
corn	hand
glue	rug
dinner	

Page 13

lamp-jeep; rug-flag; coat-tent; girl-bell
Umbrella should be circled.

Page 14

Across	Down
3. clock	1. doll
4. pot	2. top
5. log	3. cot

Page 15

The path should go through the fire, fox, feather, football, fork, and fan.

Page 16

yellow: fork, fan

purple: saw, sock

blue: corn, cake, carrot, cat, car, coat.

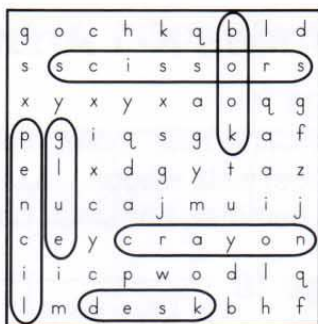
Page 17**Page 18** NOTEBOOKS**Page 19**

cow	sheep
pig	duck
turkey	chick

Page 20

turtle-table; wagon-watch; box-book;
zipper-zebra
Coin should be circled.

Page 21

Across	Down
1. duck	1. drum
3. bug	2. cub
5. mug	4. gum

Page 22

The path should go through the bug,
flag, dog, pig, and frog.

Page 23

orange: net, nut, nest
yellow: jelly, jet, jar
blue: pig, pen, pot, pencil

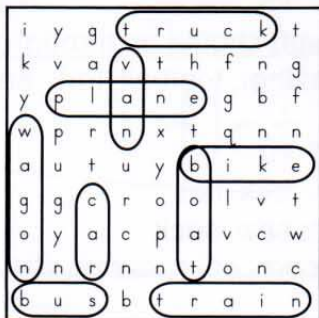
Page 24**Page 25** ON SILLY PADS!**Page 26**

vine	cape
bone	tube

cube-tube; tape-cape; cone-bone;
nine-vine

Page 27

horse-hammer; ring-rake; fish-fire;
mitten-moon
Doughnut should be circled.

Page 28

Across	Down
1. ham	1. hat
2. stamp	2. sack
4. pan	3. map

Page 29

The path should go through the bell,
pencil, wheel, shell, snail, well, doll, and
nail.

Page 30

yellow: Pam, jam, swam, clam
green: flat, cat
blue: Dan, pan, plan, ran, van, can, tan,
man

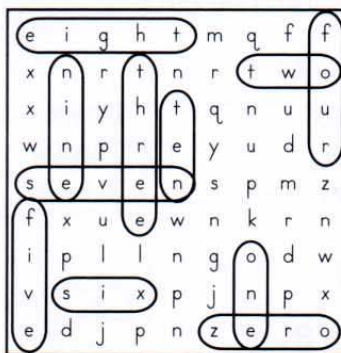
Page 31**Page 32** JELLY BEANS

Page 33

star	mouse
bow	kite
girl	a towel

Page 34

sock-saw; duck-dog; nest-nail; wagon-window
Rainbow should be circled.

Page 35

Across	Down
2. dog	1. mouse
4. turtle	3. cat
6. fish	5. rabbit

Page 36

The path should go through the sun, corn, lion, lemon, can, and moon.

Page 37

green: pin, tin, thin, chin
brown: dig, pig, big
yellow: sit, lit, it, split, knit, pit, hit, slit, bit, fit, quit

Page 38

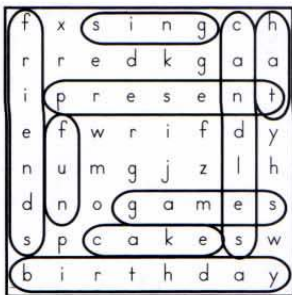

Page 39 ON A "BUZZ"!

Page 40

puppy	prize
hose	kite
cage	1. hose
2. prize	3. kite
4. cage	5. puppy

Page 41

cup-cake; foot-ball; door-bell; doll-house
1. football 2. cupcake
3. dollhouse 4. doorbell

Page 42

Across	Down
3. diamond	1. triangle
5. rectangle	2. square
	4. oval
	6. circle

Page 43

The path should go through the pig, pear, pencil, pumpkin, pen, penguin, pot, paint, pie, pillow, peach, and peas.

Page 44

blue: tape, ape, shape, grape
yellow: bake, snake, shake, wake, fake, lake, make, take, rake
red: same, came, name

Page 45

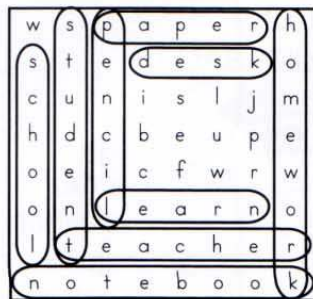

Page 46 "QUACK"ERS!

Page 47

happy	funny
sleepy	cute
noisy	pretty
neat	"pup"corn!

Page 48

Across	Down
2. gift	1. kit
5. pin	2. grin
	3. fin
	4. lip

Page 49

The path should go through the bear, pear, door, car, star, zipper, jar, chair, flower, hammer, feather, and deer.

Page 50

The real compound words are cupcake, butterfly, doorbell, cowboy, teapot, snowman, and sailboat. The picture should be a heart.

Page 51

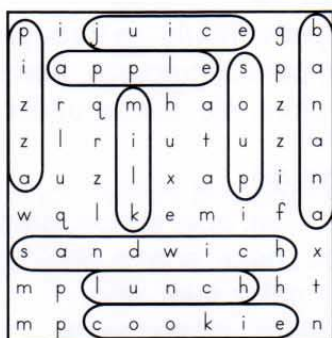

Page 52

“BISCUIT”-BALL!

Page 53

oyster	crab
lobster	seahorse
dolphin	gull
shark	octopus

Page 54

The path should go through the kite, goat, bat, hat, net, cat, boat, gate, coat, pot, and boot.

Page 55

Across	Down
3. purple	1. orange
4. green	2. blue
6. yellow	5. red

Page 56

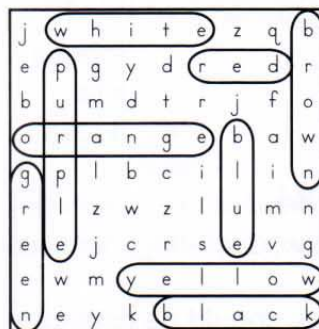

Page 57

The path should go through the web, watch, walrus, wheel, watermelon, wig, well, whale, and window.

Page 58

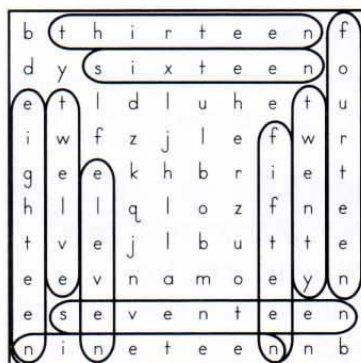

Page 59

Across	Down
2. small	1. cold
3. down	2. stop
5. wet	4. new

Page 60

Across	Down
1. legs	2. eyes
3. ears	4. hair
4. hands	
5. arms	

Look What I Did!



Place a sticker in the box for each completed page.

page 1	page 2	page 3	page 4	page 5	page 6	page 7	page 8
page 9	page 10	page 11	page 12	page 13	page 14	page 15	page 16
page 17	page 18	page 19	page 20	page 21	page 22	page 23	page 24
page 25	page 26	page 27	page 28	page 29	page 30	page 31	page 32
page 33	page 34	page 35	page 36	page 37	page 38	page 39	page 40
page 41	page 42	page 43	page 44	page 45	page 46	page 47	page 48
page 49	page 50	page 51	page 52	page 53	page 54	page 55	page 56
page 57	page 58	page 59	page 60				



Teacher Approved

**140
Stickers!**

Carson-Dellosa's Home Workbooks are perfect for building basic skills! Educate and entertain young learners with age-appropriate activities, puzzles, and games. Great for extra practice at home or school and during travel or school breaks!

Puzzles & Games Included:

- Secret codes
- Word searches
- Word scrambles
- Crosswords
- ... and more!



Carson-Dellosa

Publishing Company, Inc.
Greensboro, NC

ISBN 0-88724-723-7



50249



9 780887 247231



0 44222 14860 7

Printed in the USA